



Helicopter Safety Advisory Conference

Safety Through Cooperation - Since 1978

New Build Helideck Design Guidelines

RP Number:
161



Second Edition

Revision 1 – January 2021



HeliOffshore
Safety Through Collaboration

Published by Helicopter Safety Advisory Conference (HSAC), 2019

Recommended Practices (RP) are published under the direction of the Helicopter Safety Advisory Conference (HSAC). RPs are a medium for discussion of aviation operational safety pertinent to the transmission of product, energy exploration and production industry in the United States. RPs are not intended to replace individual engineering or corporate judgment or to replace instruction in company manuals or government regulations. Adoption of this HSAC RP as a company internal standard is the responsibility of each individual company and is highly recommended. In this HSAC RP the word 'shall' is used to indicate high value safety practices not an imperative command. Companies choosing to adopt practices recommended in this document should be aware that substitution of "shall" to "should" would likely diminish the effectiveness of the practice. HSAC encourages and welcomes suggestions for subject matter relating to this document intended to improve or update practices contained within.

Copy and use text from this document but please ensure you always use the most up to date version and use it in context so as not to be misleading, and credit the helicopter safety advisory conference helideck committee.

First published 2016 (HSAC RP 2016-1)

First Edition - Revision 1, May 2016

First Edition - Revision 2, November 2017

Second Edition, December 2019 (Renamed HSAC RP 161)

Second Edition – Revision 1, January 2021

Enquiries regarding the content of this publication should be addressed to HSAC Helideck Committee Chairman
For contact details, see HSAC Website (<http://www.hsac.org/membership-contacts>)

The latest version of this document is available in electronic format at: <http://www.hsac.org/library>

TABLE OF CONTENTS

TABLE OF CONTENTS	3
1 SCOPE	6
2 REFERENCES	7
3 TERMS, DEFINITIONS, AND ABBREVIATIONS	10
3.1 Terms and Definitions	10
3.2 Abbreviations	15
4 HELIDECK DESIGN PLANNING	17
4.1 General	17
4.2 Design Helicopter Selection	17
4.3 Helideck Design Considerations	18
4.3.1 Location	18
4.3.2 Helideck Size.....	19
4.3.3 Helideck for a Helicopter Based Offshore.....	21
4.3.4 Parking Area/Parking Transition Area.....	21
4.3.5 Obstacle Protection Sectors.....	23
4.4 Personnel Access and Egress	33
4.4.1 Access Point Signage.....	34
4.5 Fire Protection	34
4.5.1 General.....	34
4.5.2 Firefighting Personnel Access	35
4.5.3 Helideck Surface and Drainage.....	35
4.5.4 Key Design Characteristics for Fire Protection at Manned Facilities Using Principal Agent Foam	36
4.5.5 Fire Protection for Manned Facilities Using Complementary Dry Powder and Gaseous Agents	37
4.5.6 Key Design Characteristics for Fire Protection at Normally Unmanned Installations (NUIs).....	37
4.5.7 Additional Key Design Considerations	38
4.5.8 Parking Area (PA) and Parking Transition Area (PTA) Firefighting	38
4.6 Air Turbulence	39
4.7 Hot Air, Raw Gas, and Hydrogen Sulfide (H₂S) Discharge	40
4.7.1 Hot Air Discharge	40
4.7.2 Raw Gas Discharge.....	40
4.7.3 Hydrogen Sulfide (H ₂ S) Gas Discharge.....	40
4.8 Helideck Equipment and Material Handling	41
5 DESIGN PROCEDURES FOR OFFSHORE HELIDECKS	42
5.1 General	42
5.2 Helideck Design Load	42
5.2.1 Dead Weight (Mass).....	42
5.2.2 Live Load/Overall Superimposed Load.....	42
5.2.3 Wind Load.....	42
5.2.4 Helicopter Landing Load Considerations	43
5.2.5 Parking Area (PA)/Parking Transition Area (PTA) Load Considerations	44
5.2.6 Punching Shear.....	44
5.2.7 Perimeter Safety Net/Safety Shelf Loads.....	44
5.3 Installation	44
5.4 Material	45
5.5 Helideck (TLOF) Surface	45

5.6	Perimeter Safety Nets and Safety Shelves	45
5.7	Tie-down Points.....	46
6	HELIDECK MARKINGS.....	47
6.1	General.....	47
6.2	Perimeter Line Marking	47
6.3	Touchdown/Positioning Marking (TDPM).....	47
6.4	“H” Marking	48
6.5	Displaced TDPM and “H”	49
6.6	Weight (Mass) and Size Limitation Markings.....	49
6.6.1	Textual Marking Font Requirements for Helidecks.....	49
6.6.2	U.S. Customary Units.....	50
6.6.3	International System of Units (SI)	53
6.7	Helideck Obstacle Free Sector (OFS) Chevron Marking.....	54
6.7.1	Displaced Chevron from Reference Point	55
6.8	Parking Area and Parking Transition Area Markings	59
6.9	Prohibited Landing Sector Markings.....	61
6.10	Fixed Obstacle Markings	61
6.11	Helideck Name and Radio Frequency Markings	63
6.12	TLOF Surface Colors	63
6.13	Exit markings.....	64
6.14	Walkway Markings	64
7	LIGHTING.....	66
7.1	General.....	66
7.2	TLOF Perimeter Lighting.....	66
7.3	TLOF Flood Lighting	68
7.4	Parking Area and Parking Transition Area Lights.....	69
7.5	Helideck Status Light(s).....	70
7.6	Lighting of Obstructions	71
7.7	Uninterruptible Power Supply (UPS).....	72
8	FUELING STATIONS.....	73
8.1	General.....	73
8.2	Fuel Tanks.....	73
8.3	Fuel Transfer Equipment	73
8.4	Marking of Fuel Systems	74
9	WEATHER REPORTING EQUIPMENT	75
9.1	Windsock	75
9.2	Weather Measuring Equipment.....	75
9.3	Floating Facilities Additional Weather Reporting Equipment and Systems	76
10	EMERGENCY RESPONSE EQUIPMENT	77
11	COMMUNICATIONS EQUIPMENT.....	78
ANNEX A:	GUIDANCE FOR HELIDECK LIMITED PARKING AREAS AND PUSH-IN PARKING AREAS... 79	
12.1	General.....	79
12.2	Limited Parking Area	79
12.3	Touchdown Parking Circle Marking.....	80
12.4	Parking Area Markings	81
12.4.1	General.....	81
12.4.2	Parking Circle Orientation Marking	81
12.4.3	‘No Nose’ Marking.....	83

12.4.4 Limited Parking Area and Push-in Parking Area Markings.....	86
12.4.5 Parking Transition Area Markings.....	87
12.5 Lighting of Parking Transition Areas with Limited Parking Areas and Push-in Parking Areas.....	89
ANNEX B: FIREFIGHTING FOAM SYSTEMS	90
13.1 Siting of Systems	90
13.2 General Information on Foam Quantities and Application Rates.....	90
13.3 Calculation of Application Rate.....	91
13.4 Calculation of Minimum Operational Stocks.....	91
13.5 Foam Aspiration.....	91
13.6 Hose Lines and Hand Controlled Monitors:.....	91
13.7 Deck Integrated Firefighting System.....	92
13.7.1 General.....	92
13.7.2 Deck Integrated Firefighting System Nozzles	93
13.8 Foam Equipment Induction Settings and Testing.....	93
ANNEX C: ADDITIONAL HELIDECK TIE-DOWN ARRANGEMENTS	95
ANNEX D: HELIDECK TEXT FONTS	97
ANNEX E: PERIMETER LIGHT REQUIREMENTS.....	102
16.1 General.....	102
16.2 Light Intensity	102
16.3 Color	103
TABLE OF FIGURES.....	104
LIST OF TABLES	105
INDEX	106

1 SCOPE

This Recommended Practice (RP) provides a basis for planning and designing new helidecks (including facilities currently without helidecks), commonly called “new builds”, for all offshore facilities except mobile offshore drilling units (MODUs) and ships that have defined codes/guidance. It includes safety guidelines, design load criteria, helideck size, marking and lighting recommendations, and other design recommendations. These guidelines were effective with the publication of first edition of this document issued May 2016.

This document does not propose a standard helideck, but recommends basic criteria to be considered in the design of new build helidecks. It is not to be construed as being applicable to existing helidecks as of the date of publication of this document. Criteria for existing helidecks and modification or replacement of helidecks on existing facilities shall refer to HSAC RP 162 and other industry guidance.

American Petroleum Institute (API) Helideck Design documents (API 2L) is not recognized by HSAC as acceptable for either design of new build or marking/upgrade of legacy helidecks.

Note 1: The requirements for mobile offshore drilling units (MODUs) are given in the International Maritime Organization (IMO) Code for the Construction and Equipment of Mobile Offshore Drilling Units (MODU CODE) and for ships in International Chamber of Shipping (ICS) Guide for Helicopter/Ship Operations.

2 REFERENCES

The following publications, recommended practices, and industry best practices have been taken into account/reviewed in the development of these guidelines and in some cases are cited herein. The most recent edition of the documents listed shall be used, unless otherwise specified.

ORGANIZATION	REFERENCE #	TITLE
Helicopter Safety Advisory Conference (HSAC)	HSAC RP 162	Recommended Practice for Assessment, Upgrades, Modification, Replacement and Marking of Existing Helidecks http://www.HSAC.org
	HSAC RP 163	Inspection, Maintenance And Operation Of Offshore Helidecks http://www.HSAC.org
	HSAC Table Helicopter Design Criteria	Helicopter size and loading criteria (weight, dimensions, etc.) for helidecks is on the HSAC Web Site "Documents Library" with title "Tables of Helideck Design Data"
Aluminum Association (AA)	AA ADM	Aluminum Design Manual http://www.aluminum.org/news/aluminum-association-releases-2017-editions-american-national-standards-aluminum
American Bureau of Shipping (ABS)	ABS Guide	Rules for Building and Classing Mobile Offshore Drilling Units
American Petroleum Institute (API)	API RP 2 SIM	Recommended Practice for Structural Integrity Management of Fixed Offshore Platforms. For all API Documents: http://www.api.org/products-and-services/standards/purchase
	API RP 2A-WSD	Recommended Practice for Planning, Designing and Constructing Fixed Offshore Platforms
	API RP 2-FPS	Planning, Designing, and Constructing Floating Production Systems
	API RP 2A-LRFD	Recommended Practice for Planning, Designing and Constructing Fixed Offshore Platforms - Load and Resistance Factor Design

ORGANIZATION	REFERENCE #	TITLE
	API RP 2-TOP	Planning, Designing and Constructing Tension Leg Platforms
	API RP 2-MET	Derivation of Metocean Design and Operating Conditions
	API RP 14-J	Recommended Practice for Design and Hazards Analysis for Offshore Production Facilities
	API RP 500 or 505	Recommended Practice for Classification of Locations for Electrical Installations at Petroleum Facilities Classified as Class I, Division I and Division 2, Division 3
Energy Institute (EI)	EI 1529	Aviation Fueling Hose and Hose Assemblies For all EI documents: https://www.energyinst.org/information-centre/ei-publications
	EI 1550	Handbook on Equipment used for the Maintenance and Delivery of Clean Aviation Fuel
	EI 1542	Identification Markings for Dedicated Fuel Manufacturing and Distribution Facilities, Airport Storage and Mobile Fueling Equipment
European Codes (Euro code)	EN 1999 – Eurocode 9	Design of Aluminium Structures Part 1.5 – Shellstructures http://www.techstreet.com/standards/bs-en-1999-set?product_id=1649533
Federal Aviation Administration (FAA)	FAA Advisory Circular 150/5345-43G	Specification for Obstruction Lighting Equipment http://www.faa.gov/documentlibrary/media/advisory_circular/150_5345_43g.pdf
	FAA Engineering Brief No. 87	Heliport Perimeter Light for Visual Meteorological Conditions https://www.faa.gov/airports/engineering/engineering_briefs/media/eb-87.pdf
	Advisory Circular 150/5390-1B	Heliport Design Guide https://www.faa.gov/documentLibrary/media/AdvisoryCircular/150_5390_2c.pdf

ORGANIZATION	REFERENCE #	TITLE
International Maritime Organization (IMO)	IMO MODU Code	Code for Construction and Equipment of Mobile Offshore Drilling Units (MODU Code) http://www.imo.org/en/Publications/Documents/Newsletters%20and%20Mailers/Mailers/I810E.pdf
International Chamber of Shipping (ICS)	ICS Guide	ICS Guide to Helicopter/Ship Operations http://www.ics-shipping.org/docs/default-source/publications/safety-security-and-operations/ics-guide-to-helicopter-ship-operations.pdf?sfvrsn=10
International Civil Aviation Organization (ICAO)	ICAO Annex 3	Annex 3 - Meteorological Information for International Air Navigation https://www.icao.int/publications/catalogue/cat_2016_en.pdf
	ICAO Annex 14 Vol II	Annex 14 Volume II – Heliports http://store1.icao.int/index.php/annex-14-aerodromes-volume-ii-heliports-4th-edition-july-2013-volume-2-english-printed.html
	ICAO 9261-AN/903	Heliport Design and Services Manual (Part I) - DRAFT
National Fire Protection Association (NFPA)	NFPA 407	Standard for Aircraft Fuel Servicing http://www.nfpa.org/codes-and-standards/all-codes-and-standards/list-of-codes-and-standards?mode=code&code=407
	NFPA 418	Standard for Heliports http://www.nfpa.org/codes-and-standards/all-codes-and-standards/list-of-codes-and-standards?mode=code&code=418
Society of Automotive Engineers (SAE)	SAE AS 25050	Colors, Aeronautical Lights and Lighting Equipment, General Requirements http://standards.sae.org/as25050/
UK Civil Aviation Authority (CAA)	CAA Paper 2008/03	Helideck Design Considerations – Environmental Effects https://publicapps.caa.co.uk/docs/33/2008_03.pdf
	CAP 437	Standards for Offshore Helicopter Landing Areas http://publicapps.caa.co.uk/modalapplication.aspx?appid=11&mode=detail&id=523

Table 1: References

3 TERMS, DEFINITIONS, AND ABBREVIATIONS

The following terms and associated definitions are used in this document. Additional detailed guidance is covered later in the document.

3.1 Terms and Definitions

TERM	DEFINITION
D-Value	The largest overall dimension of the helicopter when rotor(s) are turning, measured from the most forward position of the main rotor-tip-path plane to the most rearward position of the tail rotor-tip-path plane or rearward extension of the helicopter structure.
Design Helicopter	A composite helicopter used in design of the helideck having the largest set dimensions and the maximum take-off weight/mass (MTOW/MTOM) of the range of helicopters for which the helideck is being designed. Note: The maximum design weight (mass) of the helideck may limit the usable weight (mass) of a helicopter, (See Design Load section 5.2 and Weight (Mass)/Size Limitation Markings section 6.5).
Deck Integrated Fire-Fighting System(s) (DIFFS)	A fire suppression system integrated into the helideck surface structure using helideck integrated pop-up or static foam/water nozzles.
Final Approach and Takeoff Area (FATO)	A defined area over which the final phase of the approach to hover or a landing is completed, and from which the takeoff maneuver is initiated and to compensate for permitted maneuvering. Note: The minimum size of the FATO is 1.0D and the FATO shape should match the shape of the TLOF.
Friction Coefficient	The coefficient of friction μ is a value that shows the relationship between two objects and the normal reaction between the objects that are involved. The coefficient of friction is dimensionless and it does not have any unit. The coefficient of friction depends on the objects that are causing friction. The value is usually between 0 and 1 but can be greater than 1. A value of 0 means there is no friction at all between the objects; such is possible with Super-fluidity. All objects, otherwise, will have some friction when they touch each other. A value of 1 means the frictional force is equal to the normal force. It is a misconception that the coefficient of friction is limited to values between zero and one. A coefficient of friction that is more than one just means that the frictional force is stronger than the normal force. The frictional force or force of friction can be

TERM	DEFINITION
	expressed as $F_f = \mu N$, where F_f is the frictional force (in Newtons), μ is the frictional coefficient (dimensionless) and N is the normal force (in Newtons).
Ground Effect	An improvement in helicopter lift capability that develops whenever the helicopter flies or hovers at a height of 1 rotor diameter or less over the touchdown or liftoff area (TLOF). It a result of the interference of the surface with the airflow pattern of the rotor system and it is more pronounced the nearer the ground is approached resulting in increased blade efficiency while operating in ground effect. Ground effect results from the cushion of denser air built up between the surface and helicopter by the air displaced downward by the rotor.
Ground Effect Area	<p>The solid area that provides ground effect.</p> <p>Note: This area can be provided by the touchdown or liftoff (TLOF) area or the touch down and liftoff (TLOF) area, plus a safety shelf (if installed).</p>
Helicopter	<p>A rotary wing aircraft that principally depends upon the lift generated by one or more power-driven rotors, rotating on vertical axes for its support and motion in the air.</p> <p>Note: This document provides requirements and guidance for the design of a helideck for helicopters with a single main rotor only.</p>
Helideck	An area on a fixed or floating offshore facility designated for the landing and takeoff of helicopters, which includes, as applicable, some or all of the supporting facilities/equipment necessary for helicopter operations, such as personnel/cargo handling, parking, tie-down, fueling, maintenance, etc.
0.83D Helideck	A helideck on which the TLOF is of sufficient size to contain a circle of diameter of 0.83D of the largest helicopter that will use the helideck.
1.0D Helideck	A helideck on which the TLOF is of sufficient size to contain a circle of diameter of 1.0D of the largest helicopter that will use the helideck.
Maximum Takeoff Mass (Weight)	A maximum allowed helicopter mass (weight) on the helideck (TLOF) based on dynamic loads incurred during take-off and landings. MTOM is used interchangeably in many documents as MTOW.
Limited Obstacle Sector (LOS)	An area on the structure side of the helideck in which obstacles may be permitted within the 150 degree or less sector, provided the height of the obstacles above the level of the TLOF is limited and within a prescribed profile.
Limited Parking Area (LPA)	A parking area of less than 1.0D and/or designed for a design load less than the design helicopter separated from the TLOF by a parking transition area (PTA) that is designed to accommodate a parked helicopter where

TERM	DEFINITION
	restrictions/limitations may apply (i.e. size of helicopter, parking area dimensions, weight (mass) or obstacles).
Metocean	The discipline concerned with the establishment of relevant environmental conditions for the design and operation of offshore structures.
Minimum Structure	<p>A structure with one or more of the following attributes:</p> <ul style="list-style-type: none"> a) Structural framing which provides less reserve strength and redundancy than a typical well braced, three-leg template type platform; b) Free-standing and guyed caisson platforms which consist of one large tubular member supporting one or more wells; c) Well conductor(s) or free-standing caisson(s), which are utilized as structural and/or axial foundation elements by means of attachment using welded, non-welded, or nonconventional welded connections; d) Threaded, pinned, or clamped connections to foundation elements (piles or pile sleeves); e) Braced caissons and other structures where a single element structural system is a major component of the platform, such as a deck supported by a single deck leg or caisson.
Obstacle	All fixed (including temporary and permanent) and moveable objects or parts of these that are located in an area intended for the safe movement of helicopters or extend above a defined surface intended to protect the helicopter or are located outside of those defined surfaces and have been assessed as a hazard to helicopters.
Obstacle-Free Dropdown Sector (OFDS)	An obstacle clear area provided below the helideck (TLOF) surface measured from the outer edge of the safety shelf or perimeter netting located around the landing area down to water level for an arc of not less than 180° that passes through the center of the landing "H" and outwards to a distance that will allow for safe clearance from obstacles below the helideck in the event of an engine failure for the type of helicopter the helideck is intended to serve.
Obstacle-Free Sector (OFS)	An area free of all obstacles above helideck level outwards to a distance that will allow for an unobstructed arrival and departure path to/from the helideck for the helicopter(s) it is intended to serve. For a 0.83D helideck or larger this sector shall encompass at least 210 degrees.
Parking Area (PA)	An area, designed to accommodate a parked helicopter of the same size and weight of the design helicopter used for the landing area and protected by a 0.33D PPA, separated from the TLOF by a parking transition area (PTA).

TERM	DEFINITION
Parking Protection Area (PPA)	A parking protection area (PPA) designed to accommodate rotor infringement beyond the combined parking transition area (PTA) and parking area or limited parking area (LPA) that extends beyond the combined PTA and LPA areas.
Parking Transition Area (PTA)	An area that separates the TLOF and parking area to provide a minimum of 0.33D clearance between landing helicopter on the TLOF and parked and fully tied-down helicopter in the (L)PA or PIPA.
Perimeter Line Marking	A 12 in. (30 cm) wide solid white line shall be used to mark the boundary of the TLOF.
Push-In Parking Area (PIPA)	A restricted parking area separated from the TLOF by a parking transition area (PTA) designed to accommodate only a fully shut down helicopter, which is ground handled to/from the TLOF and to/from the PIPA.
Reference Point	The apex/point-of-origin of the obstacle-free sector (OFS) and the limited obstacle sector (LOS).
Return Period	The average period between occurrences of an event or of a particular value being exceeded.
Rotor Diameter (RD)	The diameter of a circle made by the main rotor blades while rotating.
(Perimeter) Safety Net	A netting section around the perimeter of the TLOF, and if applicable, the parking area and parking transition area, used to provide fall protection for personnel. Note: Perimeter Safety nets do not provide ground effect.
Safety Shelf	A solid surface capable of providing ground effect around the perimeter of the TLOF and to provide fall protection for personnel.
System International Units (SI)	SI units are a system of physical units based on the meter, kilogram, second, ampere, kelvin, candela, and mole, together with a set of prefixes to indicate multiplication or division by a power of ten.
Touchdown and Liftoff Area (TLOF)	The load bearing area of the helideck on which a helicopter may touchdown or liftoff. Note 1: The minimum size of the TLOF is 0.83D. Note 2: 0.83D is approximately 1 RD.
Touchdown Parking Circle Marking (TDPC)	A parking area marking in the shape of a yellow circle used by the pilot for guidance and obstacle clearance information while maneuvering over the (L)PA.

TERM	DEFINITION
Touchdown/Positioning Marking (TDPM)	<p>A yellow circle marking on the TLOF used by the pilot for guidance and obstacle clearance information while landing, taking off, or maneuvering.</p> <p>Note: The TDPM is described as the aiming circle in some previous design documents.</p>

Table 2: Terms and definitions

3.2 Abbreviations

ABBREVIATION	DESCRIPTION
CAFS	Compressed Air Foam System
cd	Candela
CFD	Computational Fluid Dynamics
DIFFS	Deck Integrated Firefighting System
DLB	Dynamic Load Bearing
FATO	Final Approach And Take-Off Area
FMS	Fixed Monitor System
HMS	Helideck Monitoring or Motion System
IFR	Instrument Flight Rules
ℓ	Liter
LED	Light Emitting Diode
LOS	Limited Obstacle Sector
LPA	Limited Parking Area
MTOM	Maximum Takeoff Mass (Weight)
μ	See <i>Friction Coefficient</i> in Table 2
NLB	Non Load Bearing
NUI	Normally Unmanned Installation
OFS	Obstacle Free Sector
OFDS	Obstacle Free Dropdown Sector

ABBREVIATION	DESCRIPTION
PA	Parking Area
PCF	Post Crash Fire
PCOM	Parking Circle Orientation Marking
PIPA	Push In Parking Area
PPA	Parking Protection Area
PTA	Parking Transition Area
psf	Pounds per Square Foot
RD	Rotor Diameter Of The Main Rotor
RFF	Rescue and Firefighting
SHR	Significant Heave Rate
SI	System International (physical units of measurement)
TDPC	Touchdown Parking Circle
TDPM	Touchdown/Positioning Marking
TLOF	Touchdown And Lift-Off Area
UPS	Uninterruptible Power Supply
USG	U.S. Gallon (3.785 liters)

Table 3: Abbreviations

4 HELIDECK DESIGN PLANNING

4.1 General

This section provides a guide for the design of helidecks. Consideration should be given to the potential design life of the facility/field and possible future requirements, including potential of larger helicopters and/or combinations thereof, increased personnel, facilities upgrades, etc. Initial planning shall include all criteria pertaining to the design of the helideck. Valuable assistance during the planning and design phase can be provided by the aviation professionals of the helicopter operators, manufacturers and the oil and gas exploration and production companies.

Note: HSAC RP Number: 163 provides guidance for the Inspection, Maintenance, and Operation of Offshore Helidecks inclusive of design guidance for fuel systems (10.7 and Appendix 4), required emergency response equipment (11.2), and Checklists that can be used for helideck (Appendix 3, Attachment 4) and fuel system (Appendix 4, Attachment 4 and 7) design.

During the design phase of a helideck, consideration should be given to the gross weight (mass), landing load distribution, overall length (D-value), and landing gear configuration of the design helicopter the helideck is intended to serve.

For extreme cold weather operations, the design of heated helidecks, snow/ice removal, and provision of electrical power in the proximity of the helideck to use ground power units should be considered.

4.2 Design Helicopter Selection

Design criteria presented herein include operational requirements, safety considerations, and environmental aspects that can affect the design of the helideck. The following are considerations for selecting the helicopter for helideck design:

- a) Distance from onshore staging areas or helicopter bases;
- b) Proximity to other offshore helidecks, on either satellite structures or adjacent field structures;
- c) Status as to whether the facility is manned, or a normally unmanned installation (NUI) without living quarters, or a minimal structure;
- d) Helicopter transportation requirements for the facility (number of landings/takeoffs, numbers of personnel onboard the facility, etc.);
- e) Crew change requirements;
- f) Requirements for night operations, medical evacuation, or other emergency flights;
- g) Environmental conditions.

On any given day, helicopter performance is a function of many factors including the actual all-up weight (mass); ambient temperature; pressure altitude; effective wind speed component; and operating technique. Other factors concerning the physical and airflow characteristics of the helideck and associated or adjacent structures have an impact. These factors shall be taken into account in the determination of specific and

general limitations, which may be imposed in order to ensure adequate performance and safe operations. It shall also be noted that, following the instance of a helicopter engine failure, it may be necessary for the helicopter to descend below helideck level to gain sufficient speed, to safely fly away, or to land on the water, in both cases without striking the safety net/shelf or facility obstacles below the TLOF level. In certain circumstances, it may be necessary to reduce helicopter-operating weight (mass) (fuel or payload) to provide a safe operating area for the helicopter unless the issues above are addressed during the helideck design phase.

4.3 Helideck Design Considerations

4.3.1 Location

Before final location of the helideck is selected, obstruction clearances, personnel safety, and Metocean conditions, as well as proximity of the obstacle-free sector relative to flammable materials, hot and cold gas discharges, flare or vent booms, and cooler discharges should be considered. As illustrated in [Figure 1](#), the helideck shall be located so that the TLOF and associated flight paths are as far as possible outside the influence of the hot and cold gas discharges, and turbulence effects in prevailing wind conditions. See paragraphs [4.3.5.6](#), [4.6](#) and [4.7](#) for additional guidance.

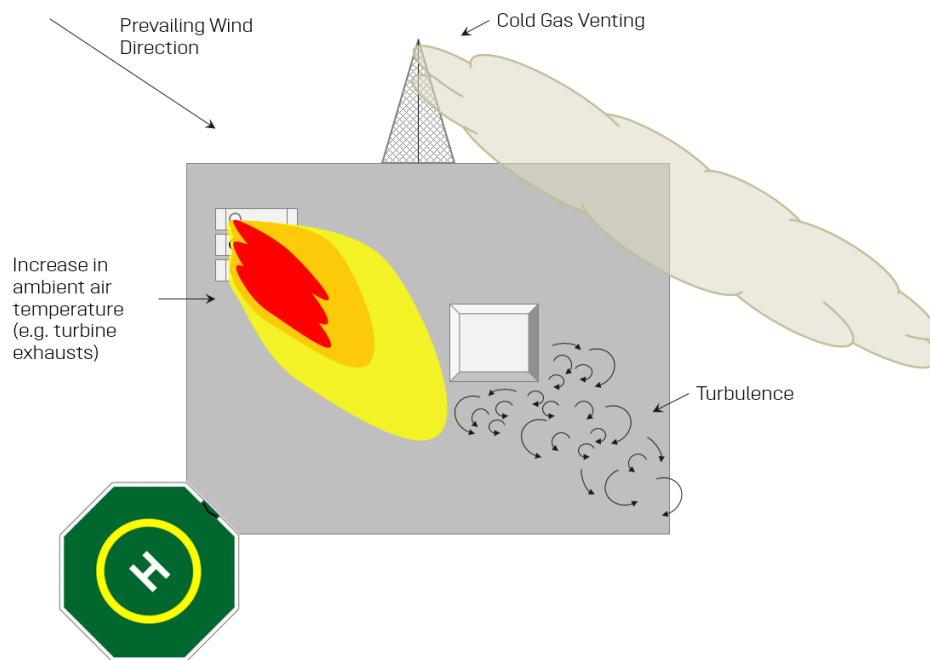

Figure 1: Helideck orientation based on wind direction, turbulence, and significant discharge sources

4.3.2 Helideck Size

A helideck shall be provided with one final approach and take-off area (FATO) co-located with a touchdown and liftoff area (TLOF). The TLOF may be any shape, but shall be of sufficient size to contain:

- a) A circle of diameter of not less than 1.0D of the largest helicopter the helideck is intended to serve providing the TLOF is surrounded with a 5 ft. (1.5 m) safety net, **or**
- b) A circle of diameter of not less than 0.83D of the largest helicopter the helideck is intended to serve providing the TLOF is surrounded with a safety shelf. The TLOF together with the safety shelf must provide an area that can accommodate a circle with a diameter not less than 1.0D. For design loading, see 5.2.

Note 1: The size of the safety shelf or perimeter safety net and structure shall be 5 ft. (1.5 m) wide (measured horizontally from the outside of the perimeter to the outer edge of the net frame) around the perimeter, see Figure 12. For design loading, see 5.2.7.

Note 2: If the D-value of the design helicopters exceeds 58.2 ft. (17.9 m) the minimum design size of the TLOF must be 1.0D or larger.

Figure 2 shows a square helideck with a 1.0D FATO and 1.0D TLOF and Figure 3 shows a square helideck with a 1.0D FATO and 0.83D TLOF. In the figures, in addition to the positions of the FATO, TLOF, and the limited obstacle sector (LOS) the TDPM, TLOF perimeter marking, and "H" are shown.

The "H" shall be co-located with the touchdown/positioning marking (TDPM) with the crossbar of the "H" lying along the bisector of the obstacle-free sector (OFS) (see Figure 2 and Figure 3). If the OFS and the LOS are swung (by up to 15°) from the norm, the bisector of the OFS need not lie on crossbar of the "H" and the "H" shall also be swung (rotated) by a corresponding amount, but shall remain in the center of the TDPM, which is usually in the center of the TLOF (unless there is a max. 0.1D displaced TDPM). The "H" crossbar shall remain in the center of the TDPM and parallel to the bi-sector of the OFS as illustrated in Figure 13. See 4.3.5.1 and Figure 13.

Note: The bi-sector is not displayed in all figures in this document.

For helidecks that have TLOF of 1.0D or larger, the FATO and the TLOF shall be coincidental i.e. be the same size and always occupy the same space. For helidecks that have a TLOF of less than 1.0D, the portion of the FATO outside the TLOF perimeter need not be load bearing; however, the perimeter line shall separate the load bearing and non-load bearing areas.

The TLOF shall provide ground effect and be designed for appropriate loads (See Section 5.2). The safety shelf on helidecks with a TLOF of less than 1.0D shall also provide ground effect.

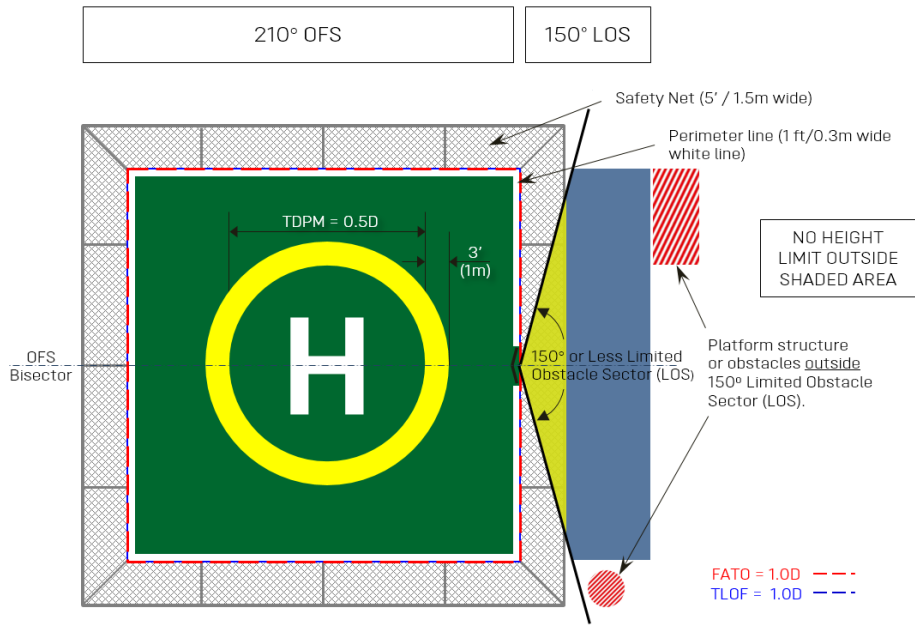

Note: A safety shelf may be used in place of a safety net

Figure 2: Square helideck with 1.0D FATO and 1.0D TLOF

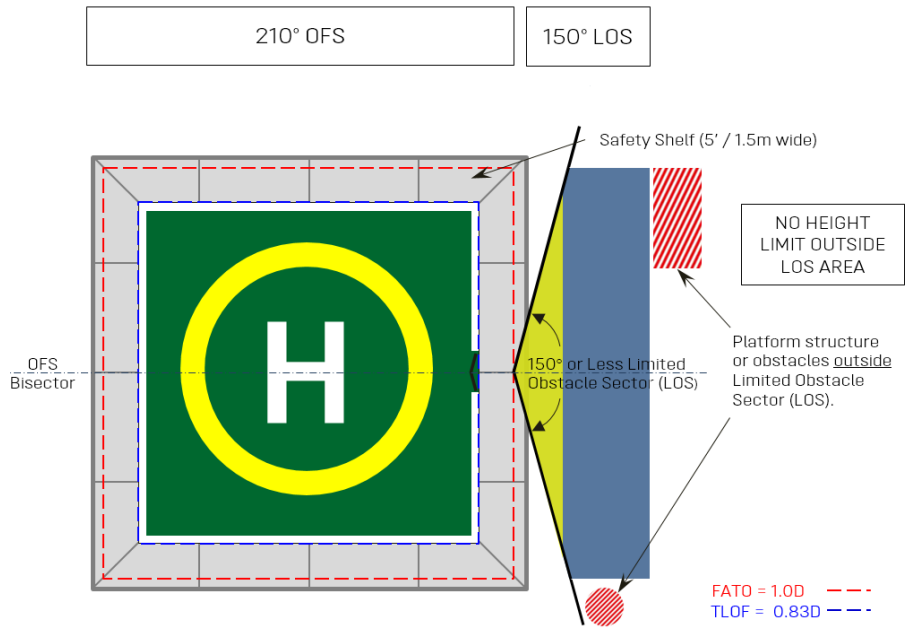

Figure 3: Square helideck with 1.0D FATO and 0.83D TLOF

4.3.3 Helideck for a Helicopter Based Offshore

If a helideck is being designed to accommodate a helicopter routinely based offshore, it shall be large enough to allow a mechanic performing routine maintenance to safely reach all parts of the helicopter. The TLOF shall be of sufficient size to contain a circle of diameter of not less than 1.0D of the largest helicopter the helideck is intended to serve; see [Figure 2](#).

Note: A 0.83D square TLOF with the helicopter parked diagonally provides an adequate area to reach all components of the helicopter, in which case proper tie-down points for this configuration shall be added (see [Section 5.7](#), [Figure 55](#), [Figure 56](#), [Figure 57](#) and [Figure 58](#)).

For cold environments, a hangar for maintenance, sheltering the helicopter from snow, ice, etc. adjacent to the helideck in which the helicopter can be towed should be considered. This can be located in the area described for helicopter parking (see [4.3.4](#)).

4.3.4 Parking Area/Parking Transition Area

A parking area (PA), connected to the TLOF via a parking transition area (PTA), should be considered when practicable and helicopter support requirements warrant. A suitable alternative is to locate a secondary helideck in another location on the facility for this purpose.

A PA provides the ability to park one helicopter, which has been shut down, and safely land a second helicopter on the TLOF. The ability to park a helicopter on an offshore installation and to be able to use the helideck for other helicopter operations at the same time provides greater operational flexibility.

The PA shall be located outside the obstacle-free sector (OFS) and outside the LOS of the helideck so that a helicopter parked on the PA is outside the LOS height limitations.

The PA, if included in the design, may be any shape and shall be of sufficient size to contain a circle of diameter of not less than 1.0D of the largest helicopter the parking area is intended to serve as illustrated in [Figure 4](#) and [Figure 5](#) for a 1.0D TLOF and 0.83D TLOF respectively. If a PA of 1.0D cannot be provided due to space or structural limitations, a limited parking area (LPA) or push-in parking area (PIPA) may be provided as outlined in [Annex A \(ANNEX A: Guidance for Helideck Limited Parking Areas and Push-in Parking Areas\)](#).

A parking protection area (PPA), as indicated in [Figure 4](#) and [Figure 5](#) shall also be provided. The PPA extends beyond the outer perimeter of the PTA and 1.0D circle of the PA by a minimum distance of 0.33D (See [Figure 4](#)). The PPA may contain objects whose presence are essential for the safe operation of the helicopter to a maximum height of 10 in. (25 cm).

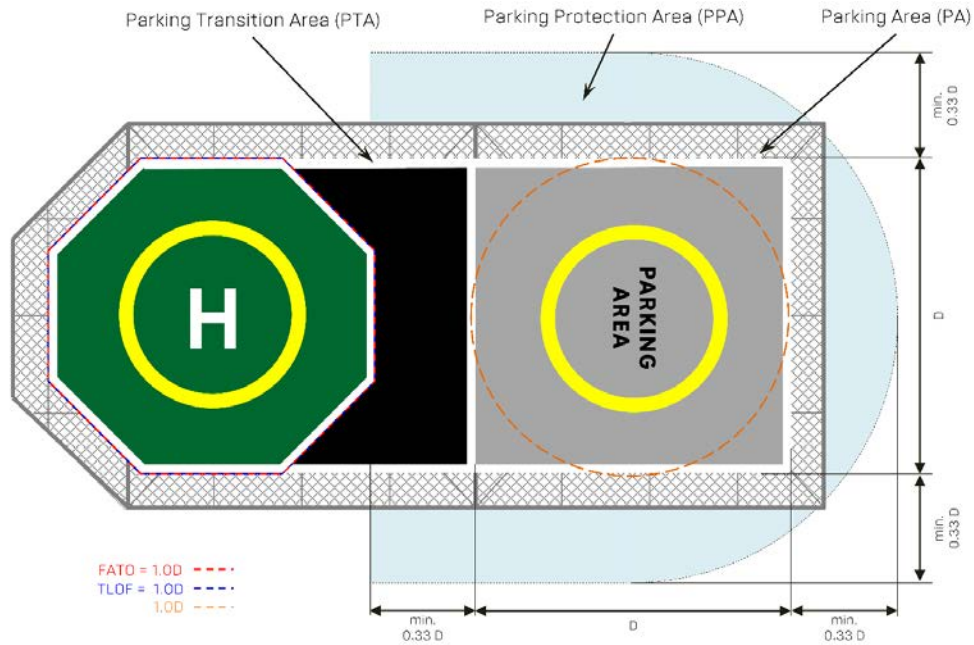

Figure 4: 1.0D FATO and 1.0D TLOF with a 1.0D Parking Area

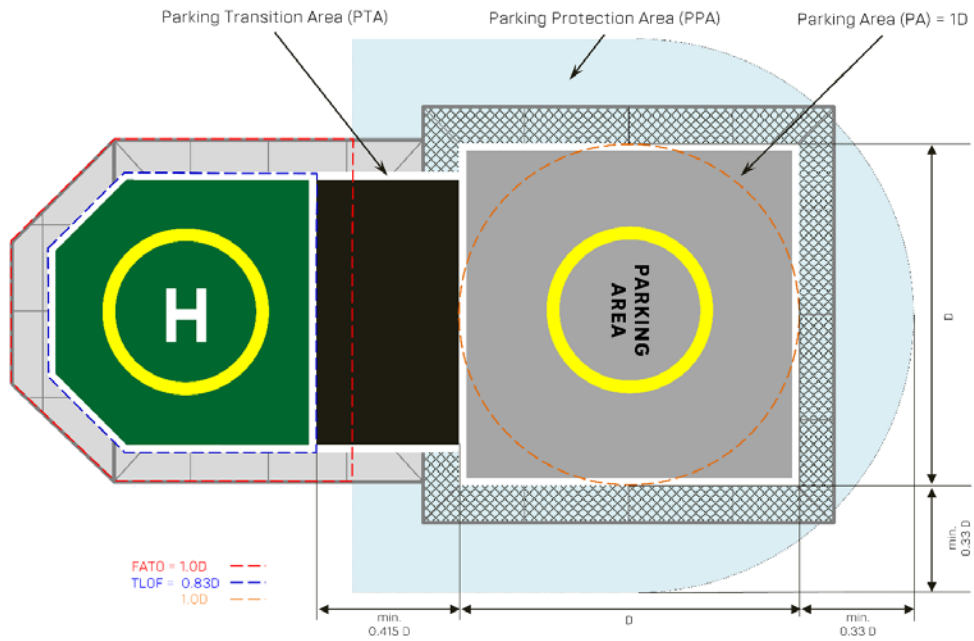

Figure 5: 1.0D FATO and 0.83D TLOF with a 1.0D Parking Area

Note: If an LPA or PIPA is provided, see Annex A for additional marking guidance.

PA and PTA design shall include surface drainage (see 4.5.3), a skid-resistant surface, and perimeter safety nets/shelves. In addition, the PA shall have tie-downs (see 5.7) equivalent to that of the TLOF design.

PAs shall be provided with one or more access points to allow personnel to move to and from the parking area without having to pass through the PTA to the TLOF.

A PTA shall be provided for the transition of the helicopter to/from the PA. The PTA divides the helideck TLOF and the PA and provides obstacle clearance between the parked helicopter and a helicopter operating on the helideck TLOF (see Figure 4).

A PTA shall separate the PA from the 1.0 D FATO of the helideck. The PTA for a 1.0D TLOF shall have a minimum width of 0.33D (see Figure 4); PTA for a 0.83D TLOF shall have a minimum width of 0.415D (see Figure 5).

Note 1: The minimum length (longest dimension) of the PTA shall be the same as the maximum width of the TLOF (see Figure 4 and Figure 5).

Note 2: For TLOF sizes less than 1.0D and greater than 0.83D, the TLOF/PA separation will need to be reviewed/calculated in the design phase.

4.3.5 Obstacle Protection Sectors

4.3.5.1 General

A helideck shall have an obstacle-free sector (OFS), an obstacle-free dropdown sector (OFDS), and a Limited Obstacle Sector (LOS). When objects are required to be located on the TLOF or in the FATO outside the TLOF, they shall be limited in height (see 4.3.5) and of a suitable frangible construction when assessed against the undercarriage design of helicopters operating to the helideck.

Note: For helidecks mounted on top of a single leg (toadstool configuration) or minimum structures in accordance with API 2A-WSD, with a 360° unobstructed access above the TLOF, an LOS is not required, but a 180 degree OFDS shall still be provided.

Figure 6 and Figure 7 show a plan view and section height requirements for the OFS and the LOS for a helideck with a circular 1.0D FATO with 1.0D TLOF and a 1.0D FATO and 0.83D TLOF respectively.

Although the extent of the LOS segments are arcs (see Figure 6 and Figure 7), these may be represented as either arcs or as straight lines. If the TLOF perimeter has straight lines, the LOS segments shall also be straight lines parallel to the TLOF perimeter (see Figure 8 and Figure 9).

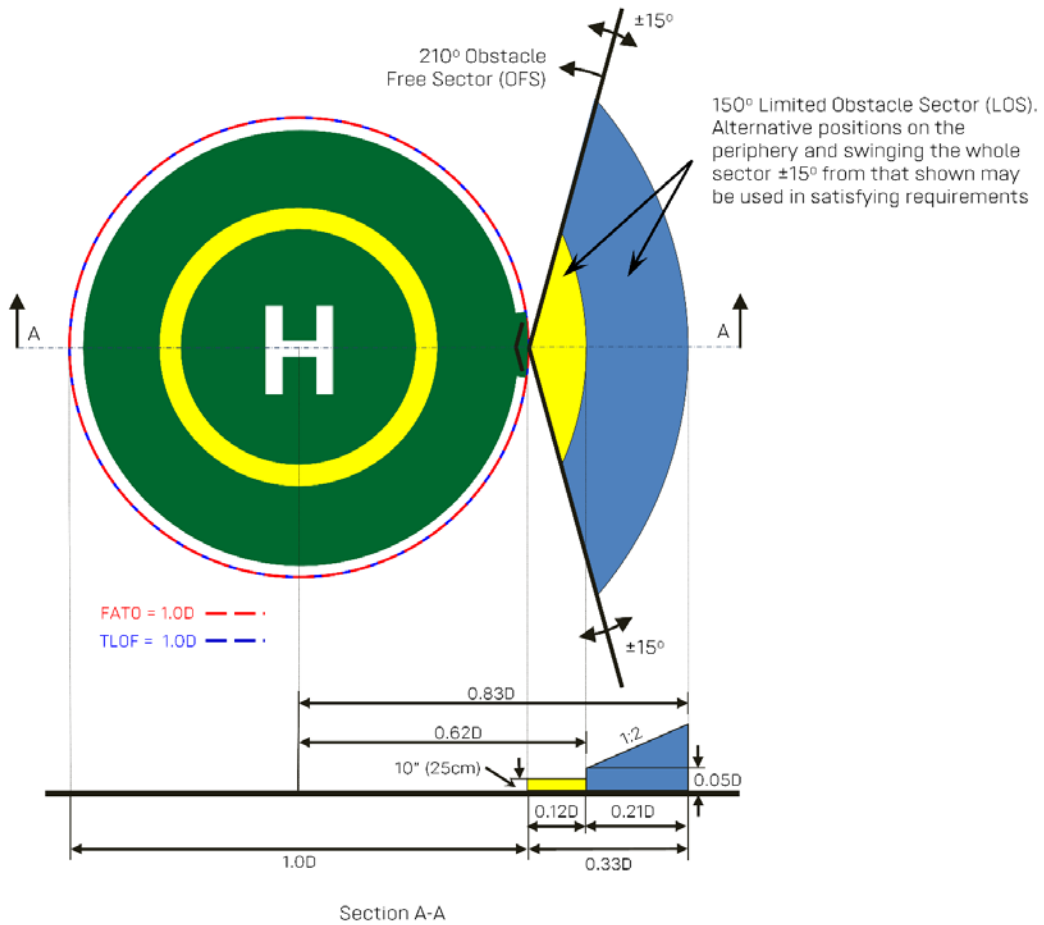

Note: For clarity Perimeter Safety Net not shown

Figure 6: Obstacle Limitation Sector and OFS for helideck with a circular 1.0D FATO and 1.0D circular TLOF

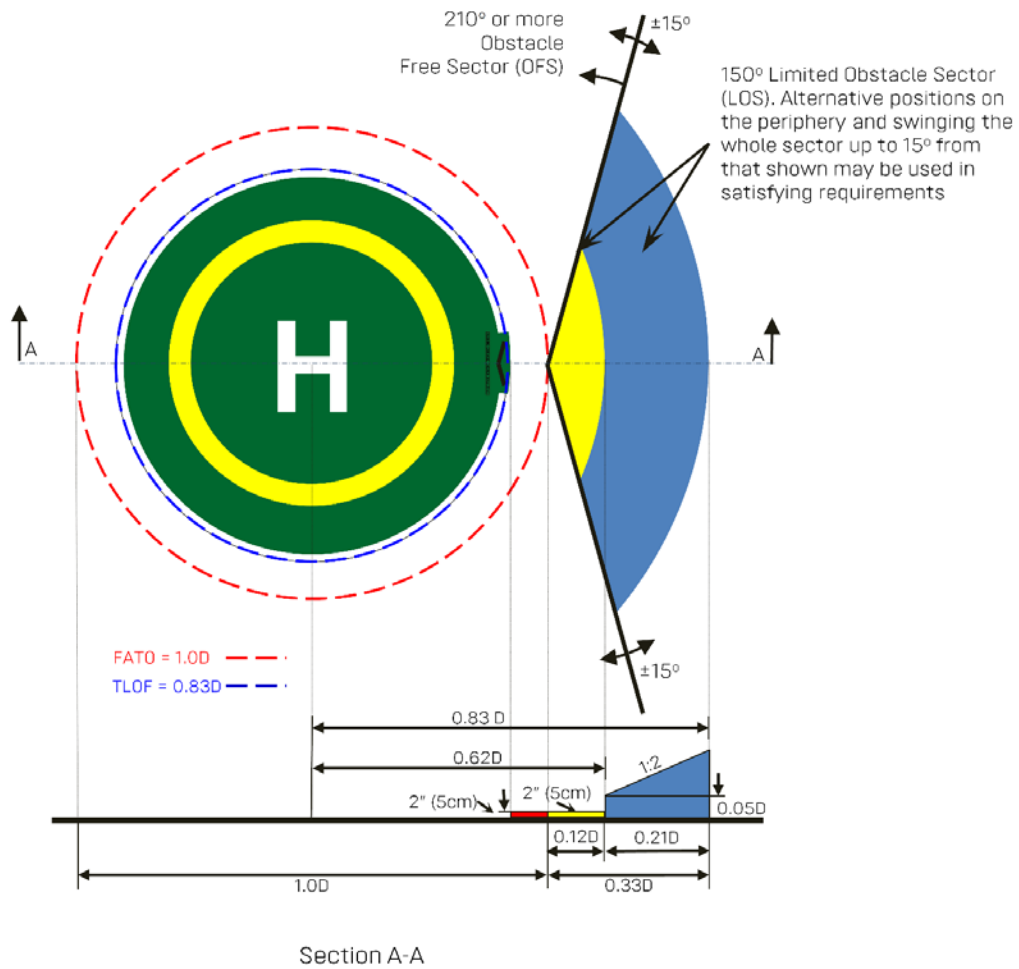

Note: For clarity Safety Shelf not shown

Figure 7: Obstacle Limitation Sector and OFS for helideck with a circular 1.0D FATO and 0.83D circular TLOF

Figure 8 and Figure 9 show the same as in Figure 6 and Figure 7 for an eight-sided/octagonal shaped helideck (TLOF) and Figure 10, Figure 11, and Figure 12 the corresponding plan and elevation requirements.

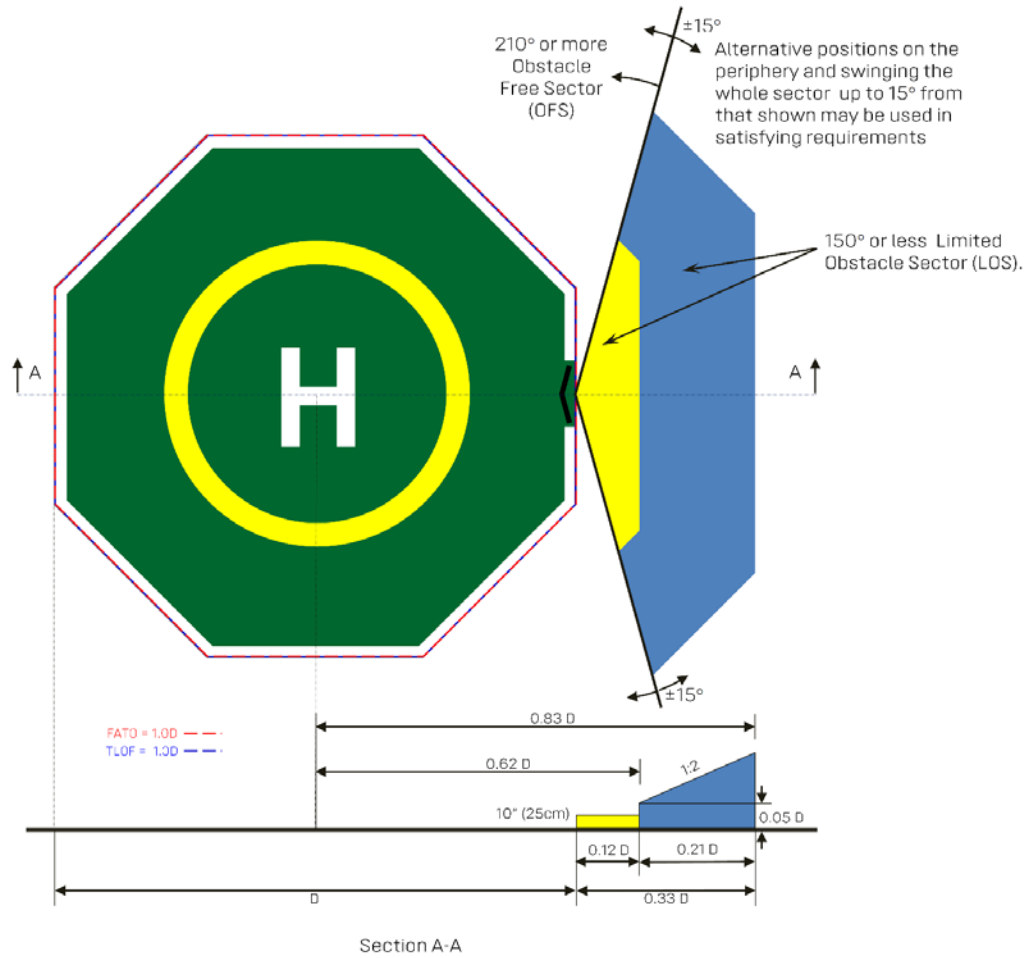

Note: For clarity Perimeter Safety Net not shown

Figure 8: LOS and OFS for octagonal helideck with a 1.0D FATO and 1.0D TLOF

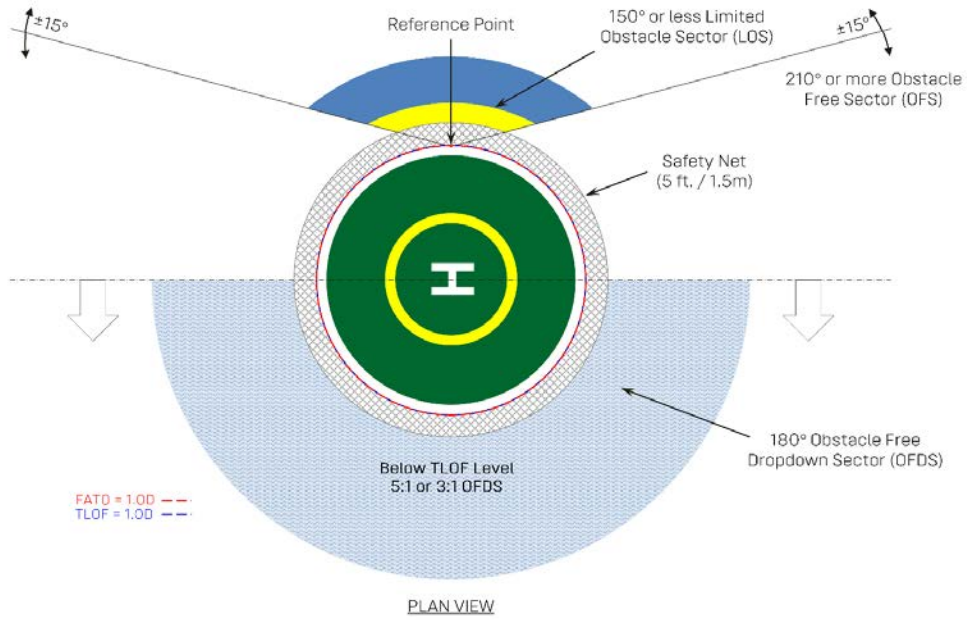

Figure 10: OFS, LOS, and OFDS below a helideck with 1.0D circular TLOF

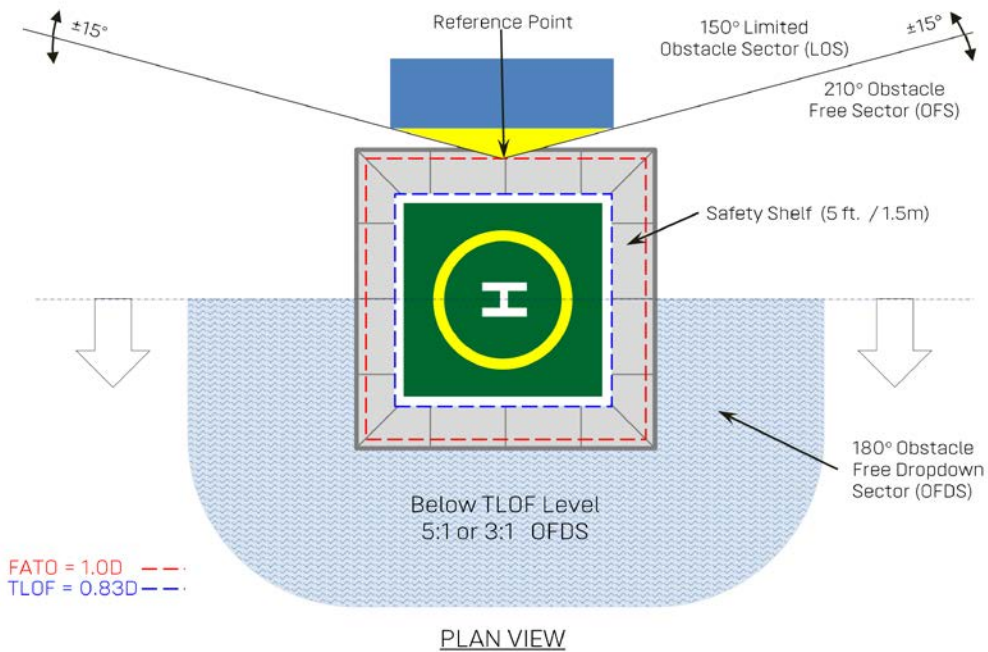

Figure 11: OFS, LOS, and OFDS below a helideck with 0.83D square TLOF

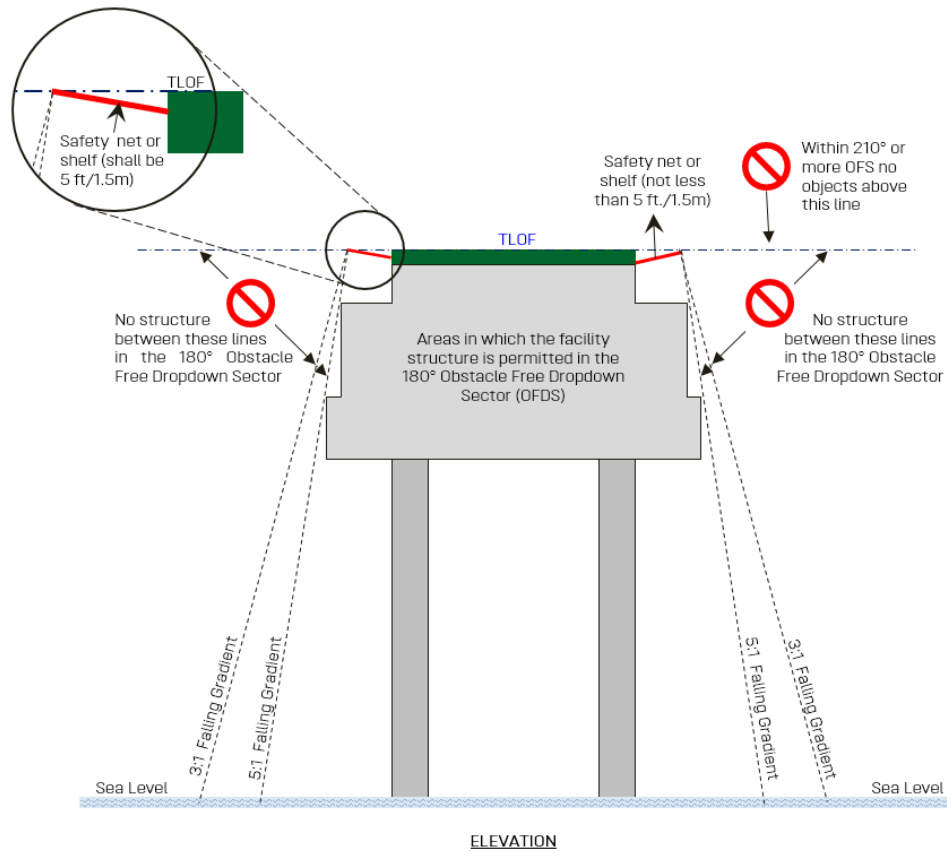

Figure 12: Obstacle Free Sector (OFS) and Obstacle Free Dropdown Sector (OFDS)

4.3.5.2 Obstacle Free Sector (OFS)

The obstacle-free sector is a virtual sector originating at and extending from the reference point (usually on the perimeter edge of the FATO for a 1.0D helideck). The obstacle-free sector (OFS) shall be a horizontal plane level at the elevation of the helideck (TLOF) surface that subtends an arc of at least 210° from the reference point located on the perimeter of the 1.0D FATO at the intersection with the LOS. The OFS shall extend outwards to a distance that will allow for an unobstructed departure path from the helideck appropriate to the helicopter(s) it is intended to serve within which no obstacles above helideck level are permitted. For helicopters operated in Performance Class 1 or 2, the horizontal extent of this distance will be compatible with the one-engine inoperative (OEI) capability of the helicopter type to be used.

Note: For helidecks located in heavily congested areas with multiple offshore facilities, it may not be possible because of adjacent facilities to achieve the entire clear departure path throughout the full obstacle-free sector (OFS) with a minimum 210 degrees, in which case operational limitations may need to be applied by helicopter operator in consult with the facility owner. The helideck orientation in relation to adjacent facilities should be considered in the design process.

The bisector of the OFS shall pass through the center of the TLOF, TDPM, and “H”; see Figure 6 through Figure 9.

The OFS may be swung (rotated) to avoid obstacles above or below the helideck (TLOF) by up to 15° in either direction (a 15° clockwise swing is illustrated in Figure 13), but the LOS shall be maintained at 150° or less (see 4.3.5.2 and 4.3.5.3). If the 210° OFS is swung, then the 180° OFDS with a 3:1 or 5:1 falling gradient (see 4.3.5.2) shall also be swung the same amount to align with the swung OFS.

This also changes the orientation of the LOS as shown in Figure 13, but in all cases, the chevron will be at the apex of the LOS. If the OFS is swung the "H" shall also be swung by a corresponding amount, and the "H" crossbar shall remain parallel to the bi-sector of the OFS as illustrated in Figure 13.

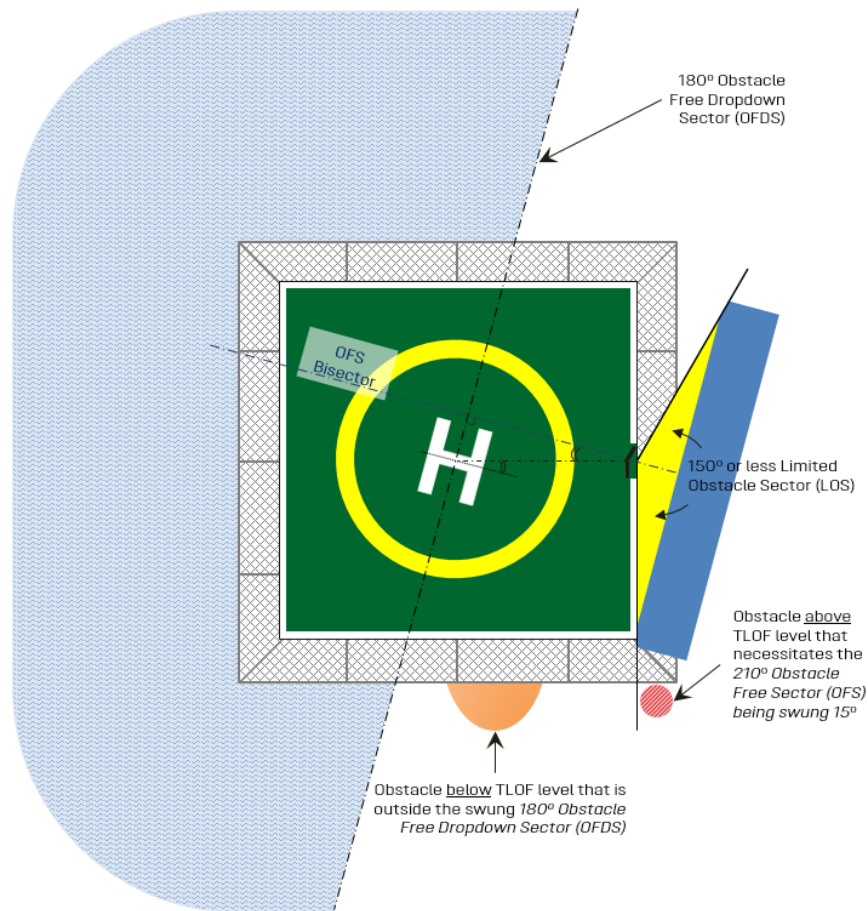

Figure 13: Obstacle Free Sector swung by 15 degrees

There shall be no fixed obstacles within the obstacle free sector (OFS) unless their function requires them to be located as follows:

- a) On the TLOF perimeter such as drainage guttering (see 4.5.3), lighting (see 7), and firefighting equipment (see 4.5);
- b) Just outside the TLOF perimeter i.e. foam monitors (where provided);
- c) Tie-down points, handrails and other items associated with the TLOF, which are incapable of complete retraction or lowering for helicopter operations.
- d) When such objects are required to be located within the TLOF, the height above the TLOF surface shall be limited to 2 in. (5 cm).

For a helideck with a 1.0D FATO/TLOF or larger, objects which are required to be located outside the FATO/TLOF, such as foam monitors (where provided), lights (see 7), etc., the height shall be limited to 6 in. (15 cm).

For a helideck with a less than 1.0D TLOF, objects which are required to be located just outside the TLOF, such as foam monitors (where provided), lights (see 7), etc., the height above the TLOF surface shall be limited to 2 in. (5 cm).

4.3.5.3 Obstacle Free Dropdown Sector (OFDS)

Below the TLOF level, within the same arc as the OFS, the obstacle-free dropdown sector (OFDS) shall extend downward from the outer edge of the perimeter safety net or safety shelf at an elevation corresponding to that of the TLOF to the water level; within an arc of not less than 180° with the origin at the center of the TDPM and "H" and outwards to a distance that will allow for safe clearance of the helicopters tail rotor from the perimeter safety net/ safety shelf edge and obstacles below the helideck during an OEI recovery maneuver resulting from a departure emergency; see Figure 10, Figure 11, and Figure 12.

The obstacle-free dropdown sector (OFDS) shall have a falling gradient ratio of one unit horizontally to five units vertically (5:1) from the outer edge of the safety net or safety shelf within the 180-degree sector.

For helidecks designed for the use of only multi-engine helicopters, the horizontal component of the falling gradient within the 180° sector may have a less demanding ratio of one unit horizontally to three units vertically (3:1); see Figure 12.

Note 1: The obstacle-free dropdown sector properties may need adjustment depending upon the performance of the selected helicopter and height of the helideck above the sea. The aircraft manufacturer shall be able to provide the necessary technical data and in most cases, this is included in the helicopter flight manual.

Note 2: Raising the helideck elevation as high as practicable above the sea level will enhance the capability of the helicopter to safely land or fly away in the event of an engine failure.

4.3.5.4 Limited Obstacle Sector (LOS)

The limited obstacle sector (LOS) is a complex sector originating at the reference point, located on the perimeter of the FATO and extending over the arc not covered by the obstacle free sector within which the height of obstacles above the level of the TLOF are limited. The LOS shall not subtend an arc greater than 150°. The dimensions and location of the LOS shall be as indicated in [Figure 6](#) and [Figure 8](#) for a 1.0D FATO with a coincidental 1.0D TLOF and as in [Figure 7](#) and [Figure 9](#) for a 1.0D FATO and 0.83D TLOF.

[Figure 6](#) through [Figure 9](#) show the two segments of the LOS and how these are measured from the center of the D-circle and the reference point on the D-circle. The first segment extends out to 0.62D from the center of the D-circle or 0.12D from the reference point. The second segment of the LOS is a rising 1:2 slope (1 vertical to 2 horizontal) originating at a height of 0.05D above the TLOF surface and extending out to 0.83D from the center of the D-circle (i.e. a further 0.21D from the edge of the first segment of the LOS or an overall distance of 0.33D from the reference point).

Note: If the LOS is made less than 150 degrees, the OFS shall be increased so that the combined LOS and OFS sectors total 360°. Such a decrease in the LOS will provide a larger clear area for the helicopter to operate. In any case, the chevron marking (see paragraph 6.7) shall depict the same angle as the LOS angle.

For a TLOF of 1.0D or larger, objects within the first segment of the LOS shall not exceed a height of 10 in. (25 cm) above the TLOF surface. In the second segment, the LOS sector surface rises at a rate of one unit vertically for each two units horizontally originating at a height 0.05D above the level of the TLOF (see [Figure 10](#)).

For a TLOF of 0.83D, objects within the first segment of the LOS, objects shall not exceed a height of 2 in. (5 cm) above the TLOF surface. In the second segment, the limited obstacle surface rises at a rate of one unit vertically for each two units horizontally originating at a height 0.05D above the level of the TLOF (see [Figure 9](#)).

Note: The height limit of 2 in. (5 cm) above the TLOF surface for objects whose function require them to be located on the TLOF perimeter, applies to the complete area between the TLOF and 1.0D FATO: it also applies to the OFS sector (see 4.3.5).

4.3.5.5 Obstacles

No obstacle shall be permitted to protrude through the obstacle free surfaces (OFS and OFDS, or exceed the profile depicted by the 150 degree LOS).

Any obstacles on the landing surface that cannot be removed and could create a hazard (e.g. raised tie-down points) should be marked by a 5-inch diameter red color circle. For operational considerations, a properly parked helicopter on a helideck with a parking area (PA) does not constitute an approach and departure obstruction as a PA should be positioned behind the 150 degree LOS where the Parking Transition Area will extend 1/3D and aligns with the 1/3D distance covered by the 150-degree LOS profile.

Objects above the helideck (TLOF) surface in the OFS for a helideck with a 1.0D FATO/TLOF or larger, which are required to be located outside the FATO/TLOF, such as foam monitors (where provided), helideck associated lights, folded down handrails, etc., the height above TLOF level shall be limited to 6 in. (15 cm).

For a helideck with a less than 1.0D TLOF, objects which are required to be located just outside the TLOF, such as foam monitors (where provided), helideck associated lights, folded down handrails, etc., the height above the TLOF surface shall be limited to 2 in. (5 cm).

4.3.5.6 Orientation

Orientation of the helideck shall be determined by reviewing the platform configuration, equipment arrangement, and prevailing wind direction (see 4.3.5.2 for additional details). The helideck shall be oriented so the helicopter can takeoff/land into the prevailing winds and any gas discharge booms shall be located on the opposite end of the facility or in a location that has the least impact on helicopter operations; see 4.7, and Figure 1.

Note: The orientation of the helideck in relation to the main structure(s) of the offshore facility and the direction of the strongest prevailing winds is a critical factor in the ability to operate helicopters safely and efficiently. Every attempt shall be made to minimize crosswind and eliminate the need for 'tail wind' approaches/departures. See the Facility Checklist in API 14J for additional guidance.

Topside arrangements, which could potentially have an adverse environmental effect on the helideck area and the helicopter performance/maneuverability (see 4.7), shall be subject to wind flow studies using wind tunnel testing and/or Computational Fluid Dynamics (CFD) analysis to establish the wind environment in which helicopters will be expected to operate if helideck location and the anticipated venting discharges for the facility may present a hazard to flight operations. Generally, a limit for the vertical airflow velocity of 5.75 ft/s (1.75 m/s) shall not be exceeded.

4.4 Personnel Access and Egress

The location of access and egress stairways for use by personnel using the helideck shall be determined from the facility configuration, equipment arrangement, and safety objectives. Two personnel access and egress routes, one primary and one secondary, shall be provided as a minimum. When possible, the personnel access and egress routes shall be outside the TLOF. The use of steep stairways or ladders shall be limited, where possible, to minimum structures. There shall be a protected passenger waiting area at a minimum of 7 ft. (2.0m) below the elevation of the helideck surface, away from any refueling equipment and fire firefighting access platforms.

One access/egress route shall be located remotely from the other; limited to emergency use and so marked as to prohibit normal passenger flow.

Handrails shall not protrude above the height of the TLOF surface; if they cannot be completely retracted or lowered for helicopter operations the height above the TLOF surface shall be limited to 2 in. (5 cm) (see 4.3.5.2). The handrails shall be retractable, collapsible, or removable and not impede access and egress. Handrails that are retractable, collapsible, or removable shall be painted or marked using other visual

materials in contrasting (preferably black and yellow) color scheme. A perimeter safety net or safety shelf shall be provided to protect personnel from falling overboard during handrail foldup/fold down operations.

Note: It may not be possible to provide two access/egress routes for helidecks mounted on top of minimum structures and may have to be limited to one, in which case this shall be documented in the helideck's information plate (HIP, See HSAC RP 164) and Helideck Operations Manual (HOM).

4.4.1 Access Point Signage.

Personnel access points shall have a sign stating "No Access during Helicopter Operations" and "Beware of Tail Rotor", or equivalent. Each marking required by this section shall be in letters at least 7.5 centimeters (3 inches) high.

4.5 Fire Protection

4.5.1 General

A risk assessment shall be completed to determine the level of fire protection necessary to contain a post-crash fire (PCF) in the event of a worst-case scenario helicopter crash in which the largest helicopter using the helideck has rolled onto its side with a full passenger load. The fire protection system shall provide adequate time to evacuate all occupants from the helicopter and helideck.

Note: Helideck surfaces with integrated firefighting nozzles can present a hazard to skid equipped helicopters, and this should be considered in the risk analysis/design of the fire protection system.

When conducting the risk assessment, many parameters should be considered to determine the scope of the fire protection equipment required for each helideck. At a minimum, parameters that should be considered include: whether the platform is fixed or floating, size of helideck, presence of a fueling station, helicopter models that are expected to service the platform including personnel and fuel capacity of such helicopters, whether the platform is manned or unmanned and, typical number of personnel on board the helicopter if the platform is manned.

The requirements and fire-protection-system performance, as a minimum, shall be in accordance with NFPA 418, in particular Chapters 5 and 8, and, when fueling systems are provided, NFPA 407. Additional Information is available in API 2A-WSD.

Note 1: The principal objective of rescue and firefighting equipment is to save lives. For this reason, the provision of means of dealing with a helicopter accident or incident occurring at or in the immediate vicinity of a helideck assumes primary importance because it is within this area that there are the greatest opportunities for saving lives. This must assume at all times the possibility of, and need for mitigating, a fire that may occur either immediately following a helicopter accident or incident or at any time during operations.

Note 2: The most important factors bearing on effective rescue in a survivable helicopter accident are the training received, the effectiveness of the equipment and the speed with which personnel and equipment designated for rescue and firefighting purposes can respond, and the effectiveness of that response.

Note 3: The portable fire extinguishing equipment shall be readily accessible to the TLOF and parking area (if installed) and ramps may be necessary to allow the equipment to be easily moved from the firefighting access platforms or other storage areas to the TLOF/PA surface.

4.5.2 Firefighting Personnel Access

The two personnel access and egress routes (see 4.5.2 for further detail) shall be designed as access points for fire-fighting/rescue personnel.

As part of each access route, a firefighting access platform shall be provided 5 ft. (1.5 m) below the TLOF surface, outside the TLOF perimeter and with direct access to the helideck. This platform is used to house firefighting equipment such as hydrants, monitors and/or rescue equipment, as well as providing a staging area for the HLO and/or firefighting/rescue crews.

If a firefighting access platform is to be located within the 180° OFDS, the firefighting access platform shall be designed to remain within the width of the safety net/shelf (5 ft. /1.5 m) or as close as practically possible.

Note: For a minimum structure in accordance with API 2A-WSD, it may not be possible to provide two access/egress routes: this shall be risk assessed in the design process.

4.5.3 Helideck Surface and Drainage

The TLOF surface shall be designed with adequate surface drainage arrangements and a free-flowing collection system that quickly and safely will direct any standing water, fuel spillage, and/or firefighting media away from the helideck surface to a safe place on the facility, and will prevent liquids from spreading to, or spilling onto, accommodation spaces or working spaces.

The drainage system can be a totally enclosed system designed to minimize access to oxygen and therefore minimize chances of combustion and fire. Burning liquids, which reach the drainage gutter, self extinguish after a very short time due to lack of oxygen.

Note 1: These systems are an integrated part of the load-bearing surface of the aluminum helideck and the inlet openings provide safe drainage of fuel and firewater/foam

Note 2: DIFFS nozzles can present a hazard to skid equipped helicopters, and this should be considered in the risk analysis/design of the fire protection system.

The design shall have:

- a) A provision for diversion of any fuel that may be spilled due to a helicopter accident, and
- b) For facilities that have a fuel system, a provision for containment of any fuel spillage.
- c) Provision to keep helideck tie-down points (see 5.7 for tie-down point design requirements) from holding liquids, while preventing leakage or non-collected draining of these liquids to lower decks,
- d) A TLOF surface slope of no more than 2% to prevent the standing collection of liquids,

- e) A drainage system constructed of metal or other materials providing adequate resistance to fire, and
- f) A design of the drainage system that precludes blockage by debris and the TLOF surface curbed (if necessary) and sealed so that spillage will only route into the drainage system.

Note 1: The drainage system may be a totally enclosed system designed to minimize access to oxygen and therefore minimize chances of combustion and fire.

Note 2: Drainage holes should be covered with covers that have openings of approx. 20mm (0.8 inches) to preclude blockage by debris while maintaining adequate flow for drainage purposes.

The capacity of the drainage system shall be sufficient to contain the maximum likely spillage of fuel on the helideck and used fire protection media. The calculation of the amount of spillage to be contained shall be based on an analysis of the fuel capacity, typical fuel loads, and fuel uplifts of the helicopter types anticipated using the helideck.

Note 1: Some regulatory authorities may have environmental requirements requiring zero discharge of fuel and/or firefighting media from the drainage system into the environment.

Note 2: Designs can be used that capture spilled liquids using a recessed drainage system for safe collection and discharge of water/fuel and passively extinguish any fire.

Note 3: A diverter valve may be installed in the drainage system to temporarily divert the open rain water to the environment when there are no helicopter operations, or fluids (e.g. fuel spill, firefighting media, etc.) collected in the drainage system to a collection tank during flight operations. The valve shall be closed during helicopter approach and take-off so that a fuel release is captured and contained.

4.5.4 Key Design Characteristics for Fire Protection at Manned Facilities Using Principal Agent Foam

A key aspect in the successful design for providing efficient, integrated helideck rescue and fire suppression is a complete understanding of the operational requirements for its use. A helicopter accident, which results in a fuel spillage with wreckage and/or fire and smoke, has the capability to render some of the response equipment unusable or preclude the use of some passenger egress routes.

Delivery of firefighting media to the helideck surface at the appropriate application rate is specified in Annex B. The foam system shall have a delay of less than 15 seconds using foam, measured from the time the system is producing foam at the required application rate. The foam concentrate shall be suitable for use with salt water to produce a foam solution that meets firefighting requirements or shall be an adequate ready-made foam solution in case of a Compressed Air Foam System (CAFS). See [ANNEX B: Firefighting Foam Systems](#) for further details on foam firefighting requirements.

The foam system shall be capable of delivering foam solution to the entire helideck surface, to include PTA and (L)PA. If simultaneous operations are scheduled, the fire fighting system shall be designed to cover both areas simultaneously, meeting all requirements in this document. Examples include:

- a) combining rotors running helicopters on both landing area and (L)PA, or

- b) running helicopter on either landing area or L(PA) and refueling activity on the other surface, or
- c) running helicopter on landing surface and simultaneous refueling activity on PIPA.

Note 1: The amounts of water required to support the fire system do not have to be stored on or adjacent to the helideck if there is a suitable adjacent pressurized water main system capable of sustaining the required discharge rate.

Note 2: See 4.3.5.1 and 4.3.5.3 for limitations on height restrictions for any firefighting equipment located on the TLOF perimeter.

4.5.5 Fire Protection for Manned Facilities Using Complementary Dry Powder and Gaseous Agents

Note 1: While foam is considered the principal medium for dealing with fires involving fuel spillages, the wide variety of fire incidents likely to be encountered during helicopter operations – e.g. engine, avionic bays, transmission areas, hydraulic systems, etc. may require the provision of more than one type of complementary agent. Dry powder and gaseous agents are generally considered acceptable for this task. The complementary agents selected shall comply with appropriate specifications (See 4.5.1). Systems shall be capable of delivering the agents through equipment that will ensure effective application (See 4.5.5).

Prevalent weather conditions can adversely affect the application of complementary agents. Training shall take this into account.

Note 2: See 4.3.5.1 and 4.3.5.3 for height restrictions for any firefighting equipment located on the TLOF perimeter. This equipment will be solely located in the LOS.

The use of foam compatible dry powder as the primary complementary agent is recommended. The minimum total capacity shall be 100 lbs. (45 kg) delivered from extinguishers of not less than 20 lbs. (9 kg) each. The dry powder system shall have the capacity to deliver the agent anywhere on the landing area and the discharge rate of the agent shall be selected for optimum effectiveness of the agent. Containers of sufficient capacity to allow continuous and sufficient application of the agent shall be provided. All applicators are to be fitted with a mechanism that allows them to be hand controlled.

The use of a gaseous agent (CO₂) in addition to the use of dry powder as the primary complementary agent is recommended and shall be provided with a suitable applicator for use on engine fires (long lance). The appropriate minimum quantity delivered from one or two extinguishers is 40 lbs. (18 kg).

The discharge rate of the agent(s) shall be selected for optimum effectiveness of the agent and the extinguishers shall be located so that they are readily available at all times. Reserve 100% on-hand stocks of complementary media to allow for replenishment because of activation of the system during an incident, or following training or testing.

4.5.6 Key Design Characteristics for Fire Protection at Normally Unmanned Installations (NUIs)

Consideration should be given to the selection and provision of foam as the principal agent. For an NUI, where helideck rescue and firefighting (RFF) equipment will be unattended during certain helicopter movements, the pressurized discharge of foam through a manually operated fixed monitor system is not recommended. For installations, which are at times unattended, the effective delivery of foam to the whole

of the TLOF area may best be achieved by means of a deck integrated firefighting system (DIFFS). As a minimum, NUIs shall have two (2) 40 lb. (18 kg) dry powder fire extinguishers available in close proximity of the helideck (i.e. stairwell landing). See Annex B ([ANNEX B: Firefighting Foam Systems](#)) for additional details.

Other combination solutions may also be considered where these can be demonstrated to be effective in dealing with a fuel fire. For example, the selection of a seawater-only DIFFS used in tandem with a passive or self-extinguishing fire-retarding helideck system described previously which demonstrated to be capable of removing significant quantities of unburned fuel from the surface of the helideck in the event of a fuel spill from a ruptured aircraft tank.

DIFFS where provided on NUIs shall be integrated with platform safety systems such that the system's nozzles are activated automatically in the event of an impact of a helicopter on the helideck.

4.5.7 Additional Key Design Considerations

Consideration should be given to automated fire protection systems instead of manned systems; these include a passive fire-retarding helideck system with a recessed drainage system for safe collection and discharge of water/fuel below the deck, ring type systems, automated oscillating fire monitor systems, and deck-integrated firefighting systems (DIFFS) in which deck-integrated nozzles are activated to extinguish a fire.

4.5.8 Parking Area (PA) and Parking Transition Area (PTA) Firefighting

This section describes the minimum requirements for firefighting equipment for PA inclusive of the PTA.

If the PA has one or more shared access locations with the TLOF area, with their own firefighting provisions, these can be used for both the TLOF and PA/PTA if these systems have capability to cover both areas.

If separate systems are installed for the TLOF and PA/PTA that the activation/deployment of firefighting systems they shall be activated independently. Although it is unlikely that the firefighting systems for both the TLOF and PA will have to be activated at the same time, it should be considered that a helicopter incident could occur while transitioning from the TLOF to the PTA and the system(s) shall be designed accordingly.

The PA shall have two sets of fire extinguishers with Complementary Dry Powder and Gaseous Agents (per para 4.5.5) which shall be readily accessible from the PA.

At a minimum, the PA shall have two water hydrants with a preference for a combined foam/water hydrant. A hydrant shall be placed on each side of the PA and must have a hose with sufficient length to cover the entire PA/PTA.

If the PA is designed to enable a helicopter to fly or hover into it, it is recommended that in addition to the water/foam hydrants, that additional fixed firefighting systems be considered. These can be additional foam monitors or (water only) DIFFS (per [ANNEX B: Firefighting Foam Systems](#)). Alternatively, a passive firefighting (recessed drainage) system can be installed to self-extinguish a post-crash fire. In lieu of manned/automatic oscillating foam monitors or DIFFS, a Compressed Air Foam System (CAFS) with foam

monitors can be considered if pressurized water supply cannot be made available in the design of the firefighting system.

4.6 Air Turbulence

Helidecks adjacent to or above large raised structures and buildings can experience turbulence in certain wind conditions. Turbulence is also encountered when helidecks are part of a building roof when air is compacted against the building's side and forced upwards to disrupt expected undisturbed airflow over the helideck surface; see Figure 14. See 4.3.5.6 and UK CAA Paper 2008/03, for additional guidance.

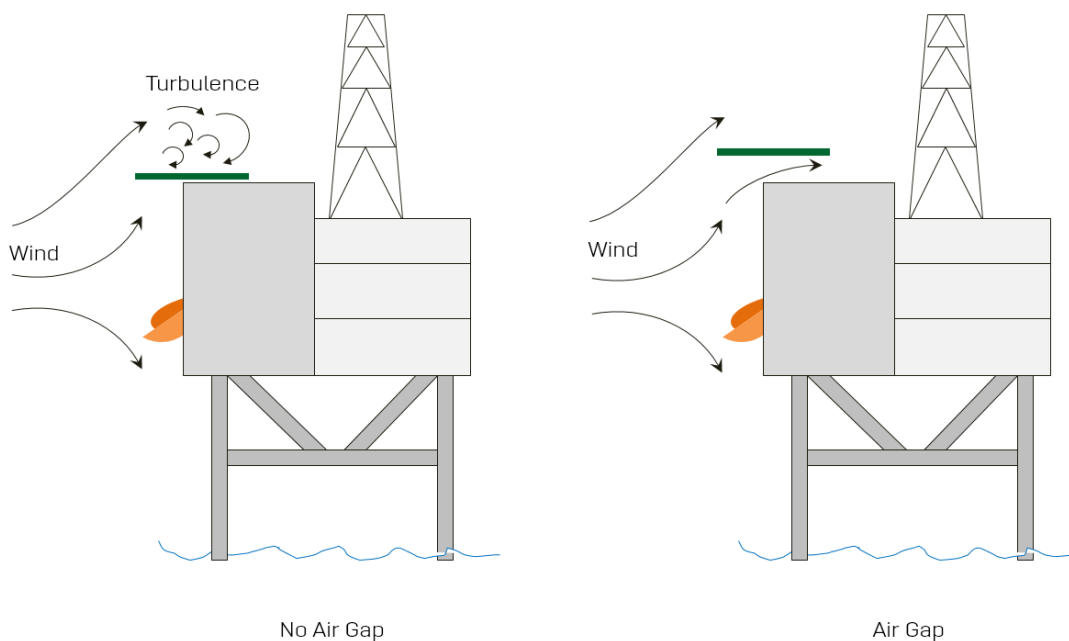

Figure 14: Turbulence with and without a helideck air gap

The following shall be incorporated in the design to reduce turbulence over the TLOF.

- The helideck shall be located as far as practicable from other buildings, derricks, cranes, etc. See API 14J for additional guidance.
- An unobstructed minimum air gap of 10 ft. (3 m) shall be provided between the TLOF and any building roof, so that potentially deflected air can flow under the TLOF: this will minimize adverse effect to helicopter operations.
- A helideck shall be designed and arranged to ensure that an unobstructed air-gap is provided which encompasses the full dimensions of the TLOF

Note: This unobstructed air gap can include necessary helideck support structure, piping, and other necessary helideck support equipment (such as foam tanks), but in no case, shall the allowed obstructions exceed 70% of the available air space.

- d) A solid safety shelf instead of a perimeter safety net can reduce the turbulence problems from adjacent structures located near helidecks. The safety shelf shall be at least 5 ft. (1.5 m) wide; this will serve to disperse the burble effect of the wind and in addition will serve to provide an increased ground effect area.
- e) The helideck design shall be subject to an airflow study (see 4.3.5.6) if any structure capable of producing turbulence on the facility exceeds helideck level, if obstructions other than helideck supporting structure are placed in the air gap, or when gas discharges could affect helicopter operations (see 4.7). It may be necessary to establish other turbulence mitigating design measures and/or operational limitations under certain wind conditions.
- f) Some objects such as supporting structure or foam supply tanks may be installed in the air gap. These obstructions to airflow shall be minimized and any deviations shall be listed in the Helideck Information Plate (HIP) in the Limitations section (See HSAC RP Number: 164) and Helideck Operations Manual (HOM).

4.7 Hot Air, Raw Gas, and Hydrogen Sulfide (H₂S) Discharge

4.7.1 Hot Air Discharge.

Hot air discharges from compressors and cooling systems adjacent to helidecks may be hazardous to helicopter operations and can drastically affect helicopter performance and appropriate restrictions shall be imposed on the use of the helideck where either of the above exists. As a rule, a limit for the vertical airflow velocity of 5.75 ft./s (1.75 m/s) shall not be exceeded.

4.7.2 Raw Gas Discharge.

The maximum permissible concentration of raw hydrocarbon gas within the helicopter operating area is 10% Lower Flammable Limit/ Lower Explosive Limit (LFL/LEL). Concentrations above 10% LFL or LEL have the potential to cause helicopter engines to surge and/or flame out. Additionally, in forming a potential source of ignition for flammable gas, the helicopter can pose a risk to the facility. It is considered unlikely that routine 'cold flaring' will present any significant risk, but the operation of emergency blow-down systems shall be assumed to result in excessive gas concentrations.

4.7.3 Hydrogen Sulfide (H₂S) Gas Discharge.

Hydrogen sulfide (H₂S) gas discharge in higher concentrations (300 ppm to 500 ppm) can cause loss of consciousness within a few seconds or affect helicopter performance.

When designing helidecks that have been identified to have any of the above conditions that may be hazardous to helicopter operations a visual warning system (e.g. Helideck Status lights) shall be provided to alert pilots of the hazard. Installation of an additional H₂S specific horn unit near the helideck should be considered for the purpose of alerting helicopter crew in cases where H₂S gas is present on or around the helideck. See 4.3.5.6 for additional guidance on wind tunnel testing and/or computational fluid dynamics (CFD) and 7.5 for status light guidance.

Sources of discharges shall be located as far as practicable away from the helideck, flight path, and oriented so the typical prevailing wind will carry the discharges away from the helideck area.

Note: Gas detectors/Sniffers (generic term used to describe automated vapor detection devices) or other detection devices (infrared, etc.) may be used to detect these discharges and to automatically activate status lights (see 7.5) when discharges present a hazard to flight operations.

4.8 Helideck Equipment and Material Handling

Lights, refueling equipment, fire extinguishers, wind indicators, and personnel access and egress routes shall be located deliberately to avoid becoming an obstruction.

Access to and egress from the TLOF (helideck) for handling material or equipment transported by the helicopter shall be addressed. For material handling, steep stairways or ladders shall be avoided. Inclusion of a crane into the facility design that can reach the TLOF should be considered; however, when not in use, the stairways, ladders, and cranes shall meet applicable helideck obstacle clearance requirements.

Note: See 4.3.5.1 and 4.3.5.3 height restrictions for any equipment, railings, etc. located on the TLOF perimeter. Ideally, equipment will be solely located in the LOS.

5 DESIGN PROCEDURES FOR OFFSHORE HELIDECKS

5.1 General

The design procedures are limited to helidecks of steel or aluminum construction located on fixed and floating offshore facilities. However, the design procedures shall not be construed as a recommendation of steel over other suitable building materials. The helideck design drawings and specifications as well as the fabrication, installation, inspection, and surveys for fixed offshore platforms and floating facilities are defined (as applicable) in API 2A-WSD, API 2FPS, API 2T, and in additional regulatory requirements i.e. USCG regulations, ABS Rules for Building and Classing Mobile Offshore Drilling Units and AA ADM, as applicable.

5.2 Helideck Design Load

As an overall design philosophy, the design shall be calculated based on either API 2A-WSD or API 2A-LRFD, but not a combination of more than one of the above-cited references.

5.2.1 Dead Weight (Mass)

The dead weight (mass) is the weight (mass) of the complete helideck decking structure including the TLOF, safety shelf or safety net, stiffeners, supporting structure, and accessories/appurtenances.

5.2.2 Live Load/Overall Superimposed Load

The term "overall superimposed load" is used in design documents to replace "live load". All areas of the helideck accessible to a helicopter, including any separate parking area, shall be designed to resist an imposed load equal to the MTOM of the design helicopter. This load shall be distributed between all the landing gear. It shall be applied in any position on the helideck to produce the most severe loading on each element considered.

To allow for personnel and cargo transfer or rotor downwash, a minimum 42 psf (2.01 kN/m²) live load shall be uniformly distributed over the entire TLOF, including parking, parking transition areas, and safety shelves.

Areas of the helideck that have loading that exceeds that of the global helideck and global topsides loading (such as fueling stations, firefighting stations, etc.) shall be accounted for in the helideck design.

5.2.3 Wind Load

Wind loading shall be used in the design of the platform, parking and parking transition area. The 100-year return period wind actions on the helicopter landing area structure shall be applied in the direction, which, together with the imposed horizontal and lateral loading, produces the most severe load condition on each structural element being considered

Storm and operational wind speed shall be applied omni-directionally (all directions) in a minimum of eight directions. Return period, wind speed variation with height and wind load calculation shall be in accordance with API 2A-WSD.

Operational wind loading shall be determined based on the projected areas of the helideck and helicopter silhouette, including helicopters on landing, parking areas, and the projected area of the framing.

Site-specific operational and storm wind loads are preferred; however, API 2MET wind loading may be used if site-specific loading is not available.

The wind area of the helideck framing shall be used to determine the extreme storm wind loading on the helideck. For operational load cases, the projected area of the helicopter(s) shall be included with that of the framing to determine the wind loading on the helideck.

5.2.4 Helicopter Landing Load Considerations

5.2.4.1 General

- a) The TLOF and its supporting structure shall be designed to withstand all the loads/forces likely to act when a helicopter lands. Helicopter parameters for the design are listed in HSAC "*Tables of Values for Common Helicopter Types*" located on the HSAC website or any latest update from the manufacturers.
- b) The TLOF shall be designed to comply with the one case that produces the most conservative stress ratios per API 2A-WSD or any other recognized calculation method or standard that applies to it – i.e. API 2A-LRFD or AA ADM).

5.2.4.2 Contact Area

The maximum contact area per landing gear, used to design deck plate bending and shear, shall conform to values listed in the HSAC "*Tables of Values for Common Helicopter Types*" located on the HSAC website or any latest update from the manufacturers.

5.2.4.3 Load Distribution

The load distribution per landing gear in terms of percentage of maximum takeoff weight (mass) shall conform to values listed in the HSAC "*Tables of Values for Common Helicopter Types*" located on the HSAC website or any latest update from the manufacturers.

5.2.4.4 Design Landing Load

- a) For the purpose of design, use the load distribution as determined in 5.2.4.3. The loads imposed on the structure shall be applied over the contact areas for the undercarriage or wheels.
- b) The design landing shall cover both a heavy landing and an emergency landing. For the former an impact load of 1.5 x MTOM (MTOW) of the design helicopter shall be used while for an emergency landing an impact load of 2.5 x MTOM (MTOW) shall be applied in any position on the landing area. Normally the emergency landing case will govern the design of the structure.
- c) When specific dynamic loading distribution data is not available it shall be assumed that the weight (mass) of the design helicopter is applied equally through the two contact areas of the main undercarriage (normally the two rear wheel assemblies) of a wheel-equipped helicopter

and equally through the two aft skid contact areas of the skid equipped helicopter listed in the HSAC "*Tables of Values for Common Helicopter Types*" located on the HSAC website or any latest update from the manufacturers, provided that the impact loads as per paragraph 5.2.4.4 are considered.

- d) When designing the helideck plate for the design-landing load, beam theory, large deflection theory (membrane concept), or other accepted design practice may be used as long as the stresses are within the allowable stress limits and do not cause permanent deformation.
- e) A lateral inertial load of 0.5 x MTOM (MTOW) shall be used in the helideck design.

5.2.5 Parking Area (PA)/Parking Transition Area (PTA) Load Considerations

For the load considerations for a hover into PA/PTA, the loads shall be developed in accordance with 5.2.4, except: the dynamic impact factor shall be 1.5 x MTOW as a minimum.

For PA/PTA where no hover into possibilities exists (push in parking area only), the loads shall be developed in accordance with 5.2.4, except the dynamic impact factor shall be 1.0 x MTOW as a minimum.

5.2.5.1 Dynamic Loads

There are potentially additional dynamic loads imposed on the platform (landing, parking, and parking transition area) due to platform response or reaction to impact that may be caused by waves, wind, earthquake, or machinery. Unless specific values are available based upon particular undercarriage behavior and deck frequency, a minimum value of 1.3 shall be assumed.

5.2.6 Punching Shear

For a TLOF where wheeled helicopters may be operated, a check shall be made for the punching shear from a wheel of the landing gear with a contact area of 2.56 x 4.06 in² (65 x 103 mm²) acting in any probable location. Particular attention to the design of the junction between the supports and the platform deck shall be given.

5.2.7 Perimeter Safety Net/Safety Shelf Loads

Perimeter Safety nets or safety shelves and supporting structure shall be designed as a minimum to support dead loads plus a minimum concentrated load of 300 lbs. (136 kg/1.33 kN) at any point.

Safety shelves and supporting structure shall also be designed to support dead loads plus the live loading as shown in section 5.2.2. For additional design requirements see paragraph 5.7.

5.3 Installation

Additional Loads/ load combinations experienced during helideck construction and installation, including but not limited to the static and dynamic forces that occur during lifting, load out, and transportation, shall be reviewed in the design.

5.4 Material

All structural materials shall conform (as applicable) to API RP 2A-WSD, API RP 2LRFD or AA ADM-1 or Euro code 9.

Note: Acceptable OEM build-in testing capabilities (inspection loops) of certain materials simplify annual testing (e.g. Helimesh or Frictape), if these build-in testing capabilities are not available for the material type chosen for the perimeter safety netting arrangement (e.g. wire-mesh fencing material), additional sacrificial panels shall be installed on top of the perimeter netting. These sacrificial panels shall be in the same environmental conditions as the safety perimeter netting and can be removed for testing purposes annually.

5.5 Helideck (TLOF) Surface

The helideck (TLOF) surface shall be a leak free solid deck or a deck with built in sub-surface passive fire protection, so that a ground cushion is created by the rotor downwash. All materials, coverings, or coatings used shall provide a non-skid surface. The minimum average surface-friction-coefficient of 0.65μ shall be achieved on the TLOF surface and including the paint markings. It is important that adequate friction exists in all directions and in worst-case conditions, i.e. when the deck is wet.

Extruded section or grid construction aluminum (or other similar material) surfaces may provide adequate resistance to sliding without painting, but they shall be coated with a non-slip material unless friction properties have been confirmed by measurement and meet the required surface friction coefficient of 0.65μ .

Note 1: For proper testing and demonstration of frictions values, guidance can be found in UK CAP437.

Note 2: When painting any helideck surface, maintain the minimum friction coefficient of 0.65μ .

Note 3: Extruded Aluminum Helidecks are difficult to measure periodically by friction tester; therefore initial OEM testing in conformance with CAP 437 will be considered acceptable for the lifetime of the helideck surface, unless the surface is coated afterwards.

5.6 Perimeter Safety Nets and Safety Shelves

The helideck shall be fitted with a perimeter safety net or safety shelf for protection of personnel 5 ft. (1.5 m) wide (measured horizontally) around the perimeter, and around stairwells where the perimeter safety net or safety shelf shall surround the entire opening. The perimeter safety net or safety shelf need not extend around stairways oriented perpendicular to the helideck perimeter. The perimeter safety net or safety shelf shall produce an outward and upward inclined surface of 10 degrees beginning below the helideck (TLOF). The outer edge shall not protrude above the helideck (TLOF).

Safety shelves shall be provided in lieu of perimeter safety nets for helidecks with (TLOF) sizes less than 1.0D. See 5.2.7 for surface loading requirements for perimeter safety nets and safety shelves.

5.7 Tie-down Points

Typical tie-down configurations for a helideck are shown in Figure 15. To derive the required number of tie-down point circles, concentric to the “H” marking, the D-value of the design helicopter shall be used in coordination with the figure. During the design, the tie-down configuration shall be configured for the full range of helicopters that may use the helideck. The tie-down points shall be to secure the helicopter to the center area of the TDPM. Tie-down point arrangements will be required in a parking area.

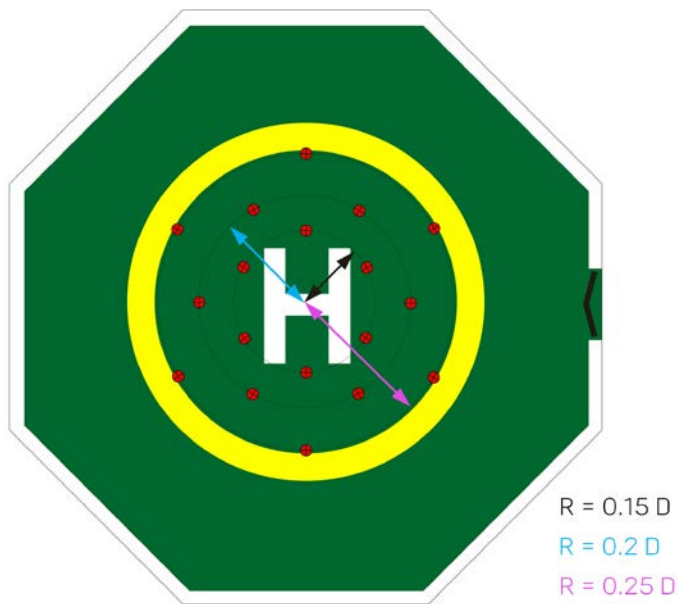

Figure 15: Tie down point arrangement

Tie-down points shall be recessed, may be equipped with covers that do not present a flyaway hazard, and have adequate sidewall clearances to allow straps to be attached. The maximum diameter or thickness of the tie-down bar attachment point shall be 1.0 in. (2.5 cm) and shall be of sufficient thickness to maintain adequate security of the helicopter.

For helideck smaller than 40 ft., eight tie-down points instead of six should be considered to allow a parked helicopter to be reoriented for maintenance purposes, etc.; see Annex C (

ANNEX C: Additional Helideck Tie-down Arrangements, Figure 55 through Figure 59).

The tie-down points shall be designed to secure the design helicopter to the helideck or parking area during the maximum anticipated environmental condition, as determined by the platform and helicopter operators.

6 HELIDECK MARKINGS

6.1 General

This section provides requirements for helideck markings. The color set used includes white, yellow, red, green (landing surface), gray (parking area), and black. The conspicuity of the mentioned markings in yellow and white can be improved by outlining them with a black outline of 4 inches (10cm), on one or both sides. See 6.10 for information on painting of aluminum helidecks.

6.2 Perimeter Line Marking

A 12 inches (30 cm) wide solid white line shall be used to mark the boundary of the TLOF.

6.3 Touchdown/Positioning Marking (TDPM)

The touchdown/positioning marking (circular) is the aiming point for a normal touchdown (landing) so located that when the pilot's seat is over the marking, the whole of the undercarriage will be within the TLOF and all parts of the helicopter will be clear of any obstacles by a safe margin. The TDPM also provides the same protection (clearance) when maneuvering/turning on the TLOF. The relationship of the TDPM to the LOS when a helicopter is occupying the TLOF is shown in Figure 16 and Figure 17 for a 1.0D TLOF and 0.83D TLOF respectively.

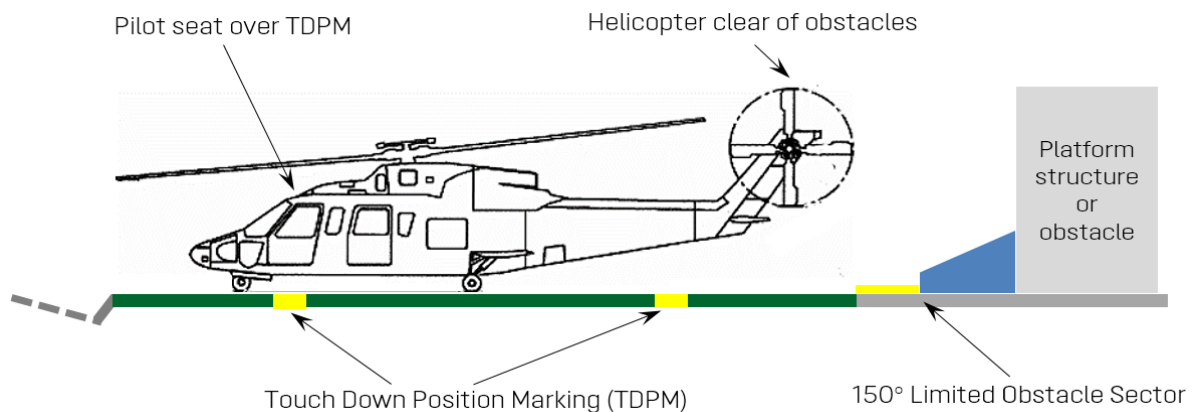

Figure 16: Relationship of the TDPM to LOS for a 1.0D TLOF

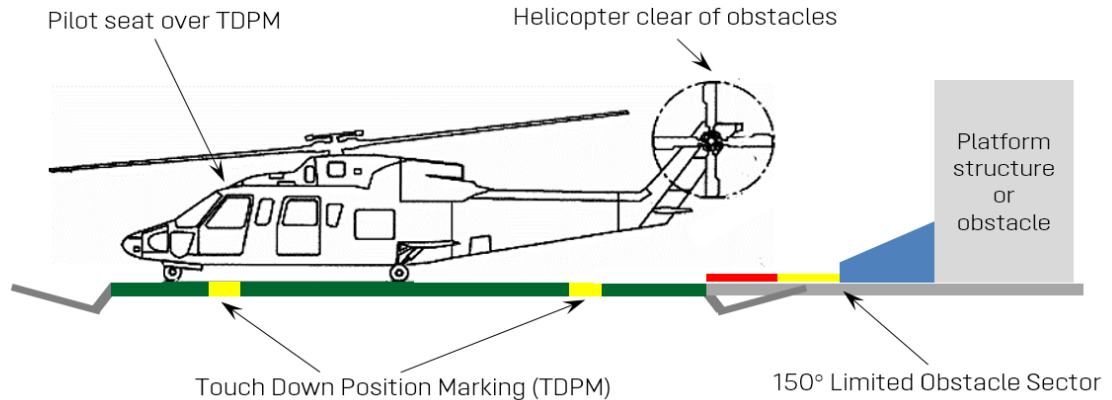

Figure 17: Relationship of the TDPM to LOS for a 0.83D TLOF

The TDPM is normally located in the center of the TLOF, unless the TDPM and H have been displaced by a maximum of 0.1D (see 6.7.1). The TDPM is a yellow circle with an inner diameter of 0.5D (i.e. radius of 0.25D) and a line width 3 ft. (1 m). The TDPM is illustrated on Figure 2 through Figure 5, and Figure 18. The conspicuity of the yellow TDPM may be enhanced by outlining the marking with a thin black line (typically 4 in. [10 cm]): this is particularly important if the TLOF surface is not painted dark green.

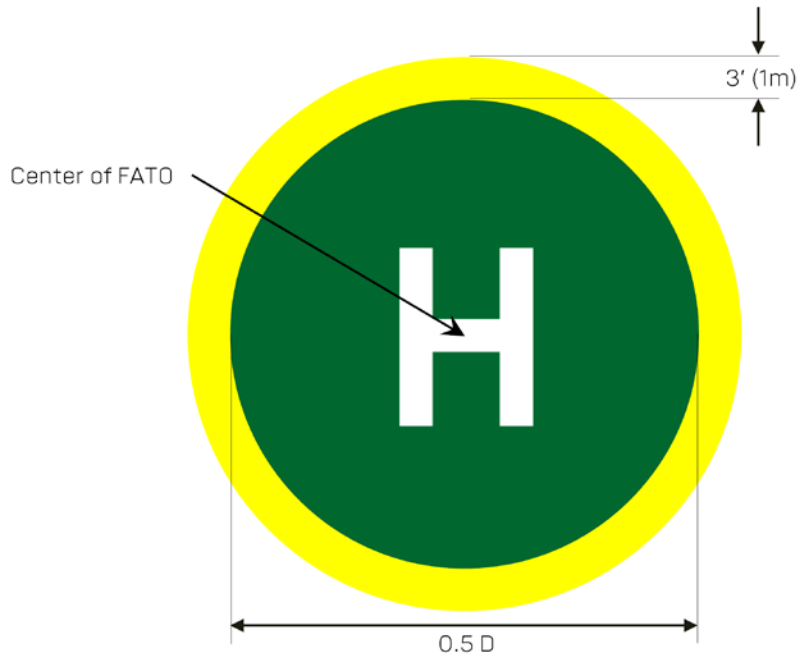

Figure 18: TDPM and "H" marking

6.4 "H" Marking

The "H" marking (international identification symbol) shall be marked in the center of the TDPM. The TDPM is usually located in center of the TLOF (see 6.3), unless the TDPM is displaced with a maximum of 0.1D.

The marking consists of the white colored letter "H", with dimensions 13 ft. (4m) high × 10 ft. (3m) wide. The width of the legs and the cross bar of the "H" shall be 2.5 ft. (75 cm) as shown in Figure 19. The "H" may be outlined with a 4 in. (10 cm) wide black outline to enhance conspicuity.

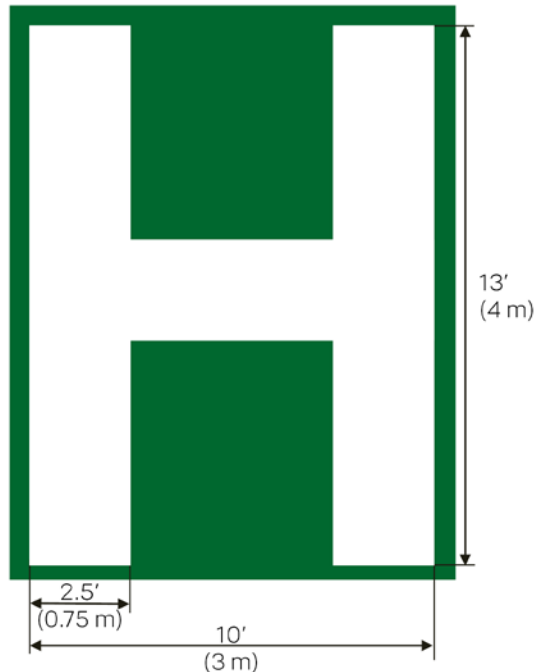

Figure 19: Helideck 'H' Marking

The "H" shall be marked co-located with the TDPM with the crossbar of the "H" lying along the bisector of the obstacle-free sector as shown in Figure 2 through Figure 5.

Where the OFS is swung in accordance with 4.3.5, the positioning of the TDPM and "H" shall comply with the swing criteria and positioning as specified in 4.3.5.2. The "H" crossbar shall be orientated so that the bar is parallel to the bisector of the swung sector. See Figure 13, 4.3.5.1, and 4.3.5.3 for additional detail.

6.5 Displaced TDPM and "H"

On a helideck the center of the TDPM Circle will normally be located at the center of the TLOF, except that the marking may be offset away from the origin of the OFS by no more than 0.1D where an aeronautical study indicates such offsetting to be beneficial, provided that the offset marking does not adversely affect the safety of flight operations or ground handling issues.

6.6 Weight (Mass) and Size Limitation Markings

6.6.1 Textual Marking Font Requirements for Helidecks

Helideck textual markings require maximum legibility while minimizing the area being occupied by the letters and numbers on the helideck and shall be in contrasting color to the background color. All textual markings on helidecks shall use the Clearview Hwy 5-W as the standard font type. However, where horizontal spacing has to be reduced in order to keep helideck markings from overlapping, the horizontal width restricted variant Clearview Hwy 5-W(R) may be used. Details and diagrams regarding the Clearview Hwy 5-W and 5-W(R) font type are provided in Annex D (ANNEX D: Helideck Text Fonts).

Note: The letters and numbers in the Annex D charts are based on upper case letter height of 4 in. (10 cm) and shall be scaled (adjusted) to the height defined in this document for the various markings.

Since a helideck is limited to helicopters of a certain gross weight (mass) and "D" size, the TLOF shall be marked to indicate the design weight (mass) and D-value limitations. The actual size of the TLOF, which provides useful information to the pilots using the helideck, shall also be marked.

The size of a non-rectangular (i.e. square, octagonal, hexagonal, pentagonal, or circular) TLOF shall be indicated by a single number representing the diameter of the largest circle that can be contained within the TLOF. Dimensions of rectangular TLOFs shall be indicated by the length (L) times the width (W) where L is measured from the TLOF edge marked with the chevron to the opposite TLOF edge and W is measured between the TLOF edges perpendicular to the L measurement as shown in Figure 20. These dimensions shall not include the safety net or solid safety shelf.

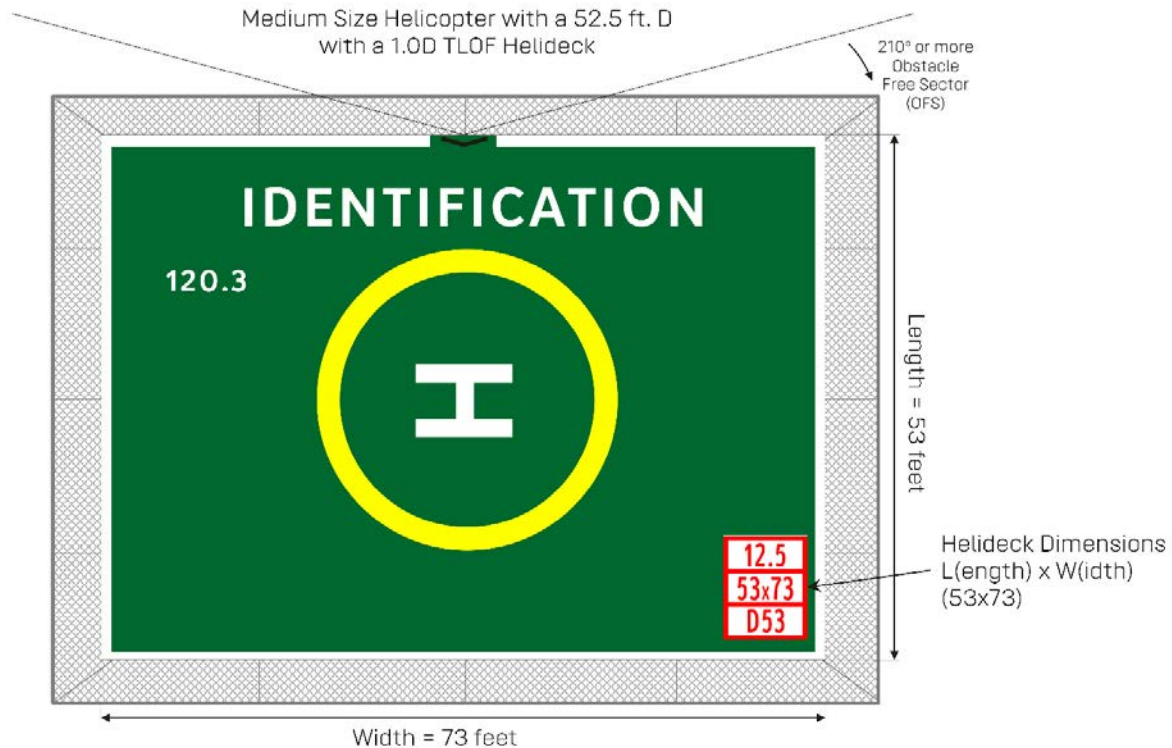

Figure 20: Size and weight markings for 1.0D 52.5 ft. medium helicopter rectangular helideck

6.6.2 U.S. Customary Units

System of International (SI) unit equivalents shall only be used for marking the weight (mass) limit or size limitation in locations where SI units are used (see 6.6.3).

The recommended method of designating the helideck (TLOF) limitations is to indicate the maximum design load and the design D-value, together with the actual TLOF size (see 6.6.1), in a three-tiered box as shown in Figure 21.

The maximum design load of the helideck shall be indicated in terms of 1000 lbs. by a two or three digit number with one decimal point rounded down to the nearest 100 pounds i.e., 15,675 lbs. shall be marked as "15.6". Below this design weight (mass) the actual TLOF size shall be indicated with the dimension rounded down to the nearest one foot and below this the allowable helicopter size in terms of the "D" dimension rounded up to the nearest one foot shall be marked with a letter "D" in front of the D-value.

Note: A helideck with a 15,000 lb. design load shall be marked as "15.0" and not "15"

The box and numerals shall be of such size as to be readily discernible by flight crew during confirmation of the correct landing site. To achieve this, the design load and D size limitations and the actual TLOF size rounded down to the nearest foot shall be marked in a box, outlined in red, in red numerals on a white background as shown in Figure 21. The height of the numbers and letters shall be 2 ft. (0.6 m) with the line width of the box and the minimum separation between the numbers/letters and the frame of box, approximately 5 in. (12 cm). For smaller helidecks (less than 40 ft. [12 m]) where space may be limited, the height of the figures may be reduced to 18 in. (45 cm). The width of the box will depend on the actual numbers since although the height is defined the width varies depending on the actual number.

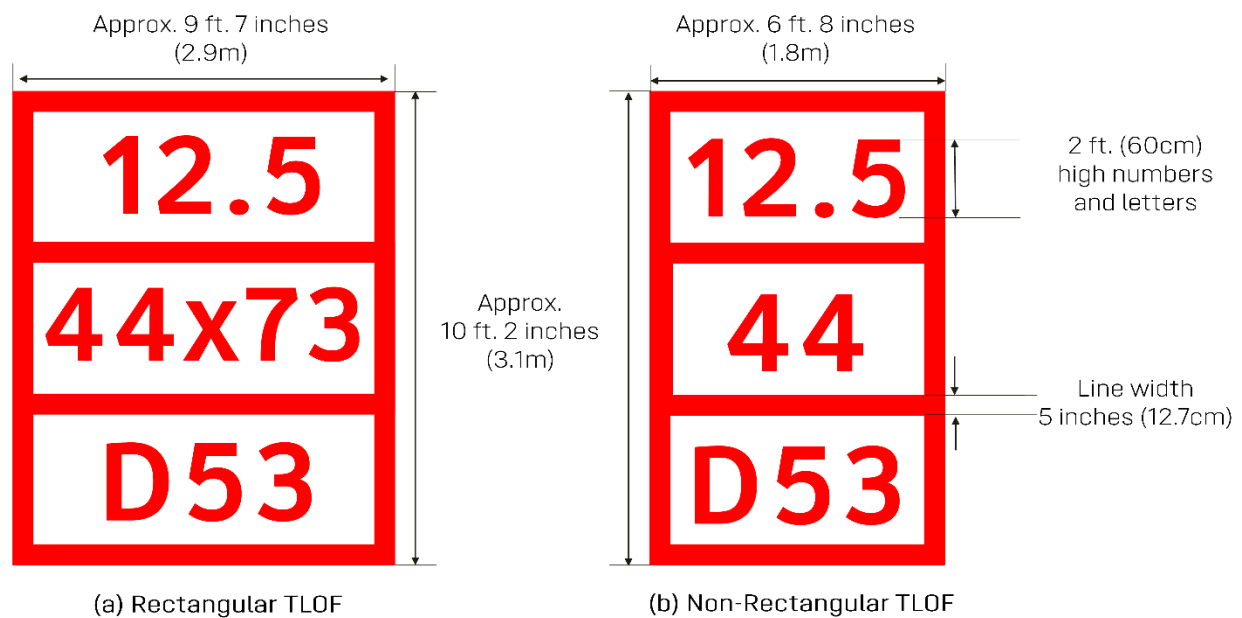

Note: Dimensions illustrated refer to 0.83D TLOF designed for a design helicopter with a D-Value of 53 feet and MTOM of 12,500 lbs .

Figure 21: Helideck size and weight markings in U.S. customary units

The weight/size limitation and the actual TLOF size box marking shall be oriented in the same direction as the helideck name. It is recommended that on a square or rectangular helidecks the box shall be located on right-hand side relative to the principal direction of approach (when facing the helideck) as illustrated in Figure 22. For circular, hexagonal and similar shapes the box shall be located on right-hand side of the TLOF and if feasible outside the TDPM, oriented in the same direction as the helideck name as shown in Figure 23.

Note: On a small TLOF the size/weight box may overlap the TDPM.

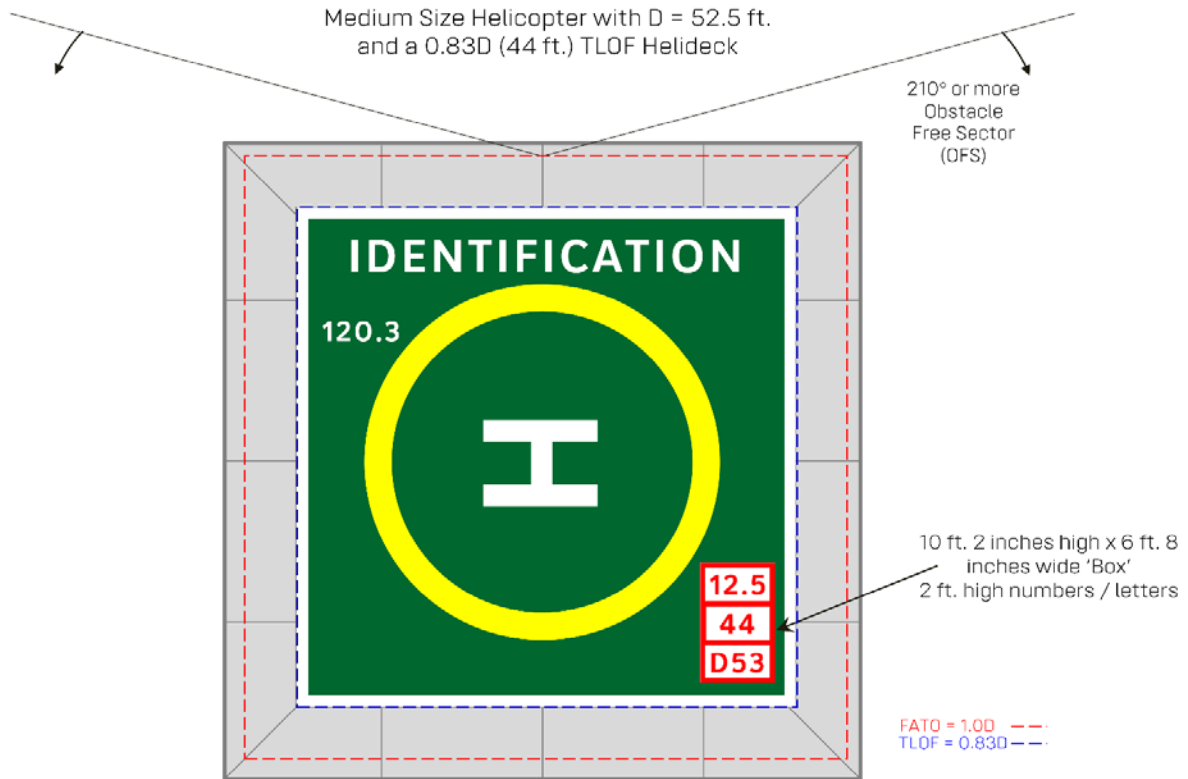

Note: Chevron markings not depicted.

Figure 22: Size and weight markings for a 0.83D square helideck

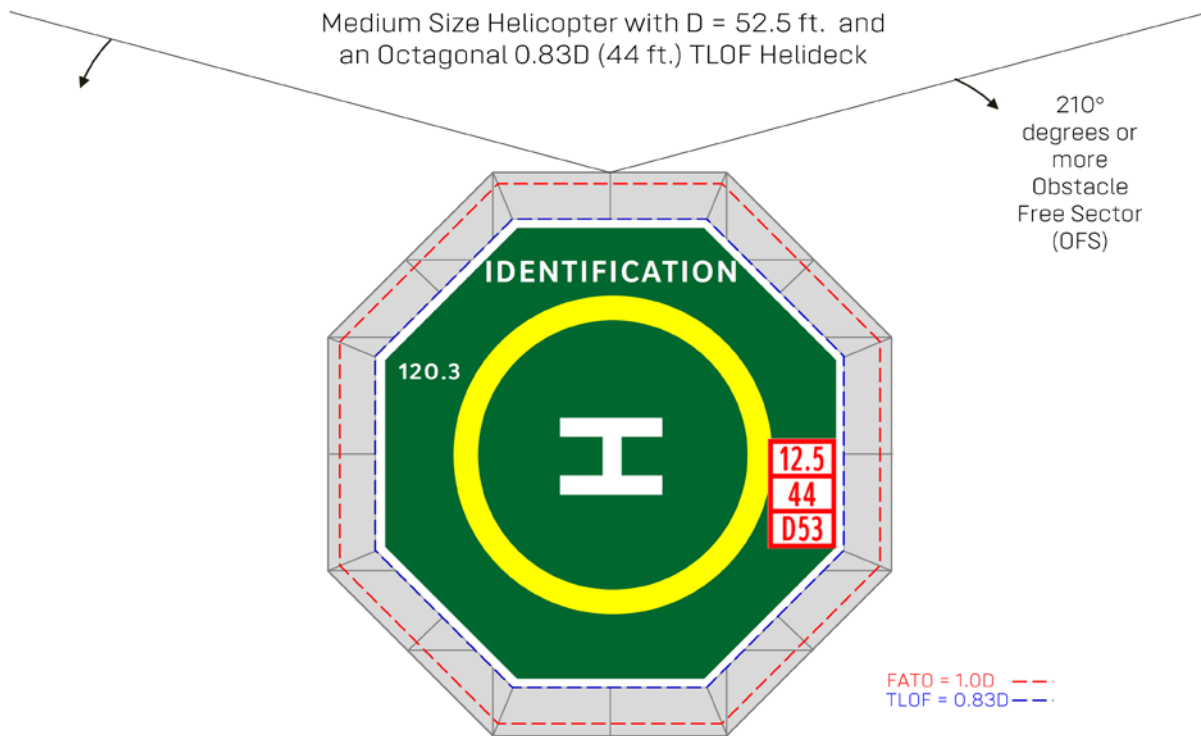

Note: Chevron markings not depicted

Figure 23: Size and weight markings for medium helicopter 0.83D octagonal helideck

6.6.3 International System of Units (SI)

U.S. Customary unit equivalents shall not be used for marking the mass (weight) limit or size limitation in locations where SI units are used.

The recommended method of designating the helideck limitations is to indicate the maximum design load of the helideck in terms of 1000 kg (tonnes) by a two or three digit number with one decimal point rounded down to the nearest 100 kg followed by the letter "t" i.e. 7250 kg shall be marked as 7.2 t. The maximum design load marking shall be marked in white, located on the upper left-hand section of TLOF and so arranged as to be readable from the preferred final approach direction.

Note: A helideck with a 12,000 kg design load shall be marked as 12.0t and not 12t as shown in Figure 24

The allowable helicopter size in terms of the D dimension rounded to the nearest one metre with 0.5 rounded down. The D-value shall be marked in three separate interrupted sections of the perimeter line marking so it can be seen from the actual approach direction. First location is opposite side from the chevron marking and both other markings are on the remaining perpendicular perimeter line sections. The D-value marking shall consist of white numbers of (0.9m) height, which can be outlined with a 4-inch (10 cm) wide

black outline for conspicuity. Reading of the marking shall align with approach to the helideck (readable from the outside when looking towards the helideck).

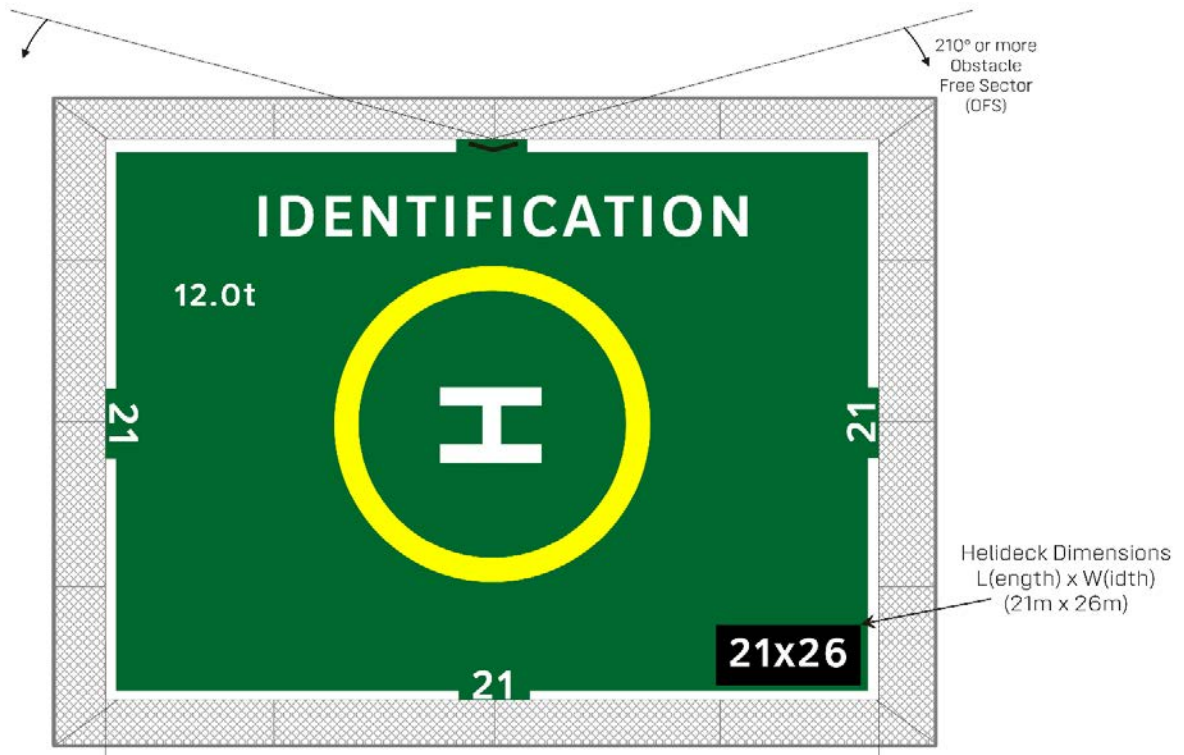

Figure 24: Size and weight markings for SI units

The mass limit shall be marked in white numerals (followed by a letter "t") on the TLOF surface or a contrasting background in the upper left hand area as shown in Figure 24.

The actual TLOF size dimensions shall be marked on the TLOF surface, with white numerals on a black background. The marking shall be located in the bottom right hand corner as shown in Figure 24. The marked number shall be rounded to the nearest one meter with 0.5 rounded down. For each marking, the height of the numbers shall be 0.6 m (2 ft.). For smaller helidecks where space may be limited, the height of the figures may be reduced to 45 cm (18 in.).

The design load marking, actual TLOF size and D-value marking in white may be enhanced, if required to improve conspicuity, by overlaying the white marking on a black painted background or using a 4 inch (10 cm) black outline.

6.7 Helideck Obstacle Free Sector (OFS) Chevron Marking

The origin of the 210° OFS for approach and take-off as specified by the point of origin shall be marked on the helideck by a black chevron on the perimeter line. The purpose of the chevron is to provide visual

guidance to the HLO so that he can ensure that the 210° OFS is clear of obstructions before giving a helicopter clearance to land.

On a 1.0D helideck the FATO and TLOF are the same size and therefore the chevron will only be slightly displaced from the point of origin/reference point (TLOF/deck edge) when marked on the perimeter line (see [Figure 28 Note 1](#)).

Note: On helidecks where there are no obstacles for 360°, no chevron is required.

6.7.1 Displaced Chevron from Reference Point

6.7.1.1 Displacement due to less than 1.0D TLOF

On less than 1.0D size helidecks where there is no room to place the chevron at the reference point, the chevron marking, but not the point of origin, will therefore be displaced towards the D-circle center and also marked on the perimeter line with an additional marking underneath to identify the displacement distance and direction.

The distance displaced shall be indicated as shown in [Figure 25](#) for a TLOF less than 1.0D. The marking shall be a black rectangle (thin black line) around the black wording "WARNING DISPLACED CHEVRON -X.X ft. (-Y.Y m)" where X is the displaced distance of the chevron marking inward from the point of origin outside of the TLOF.

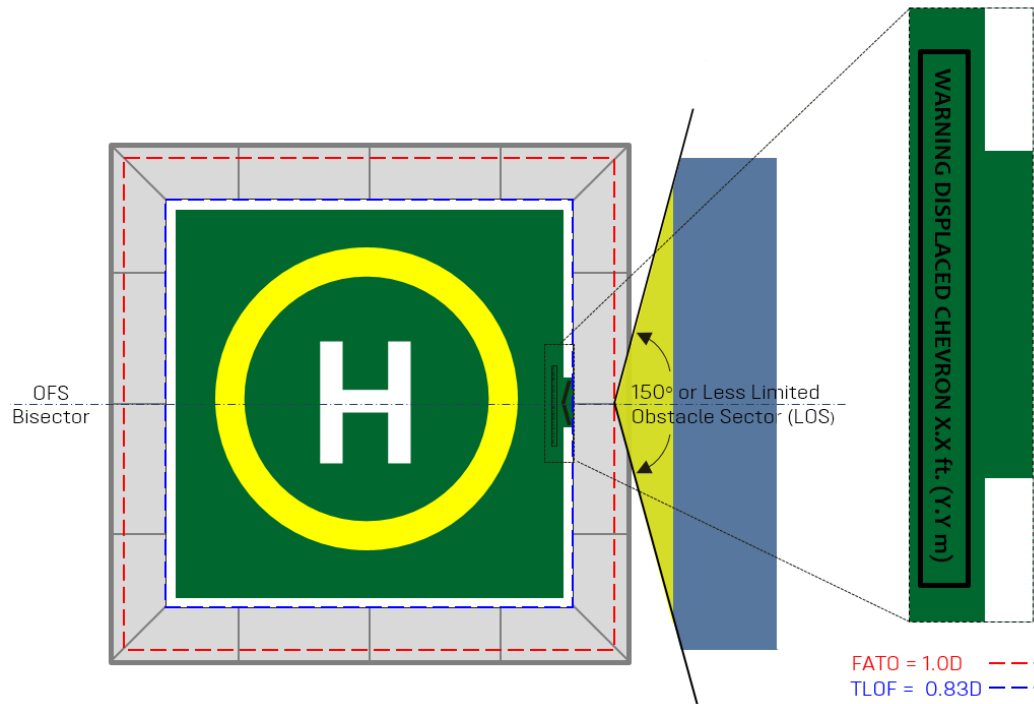
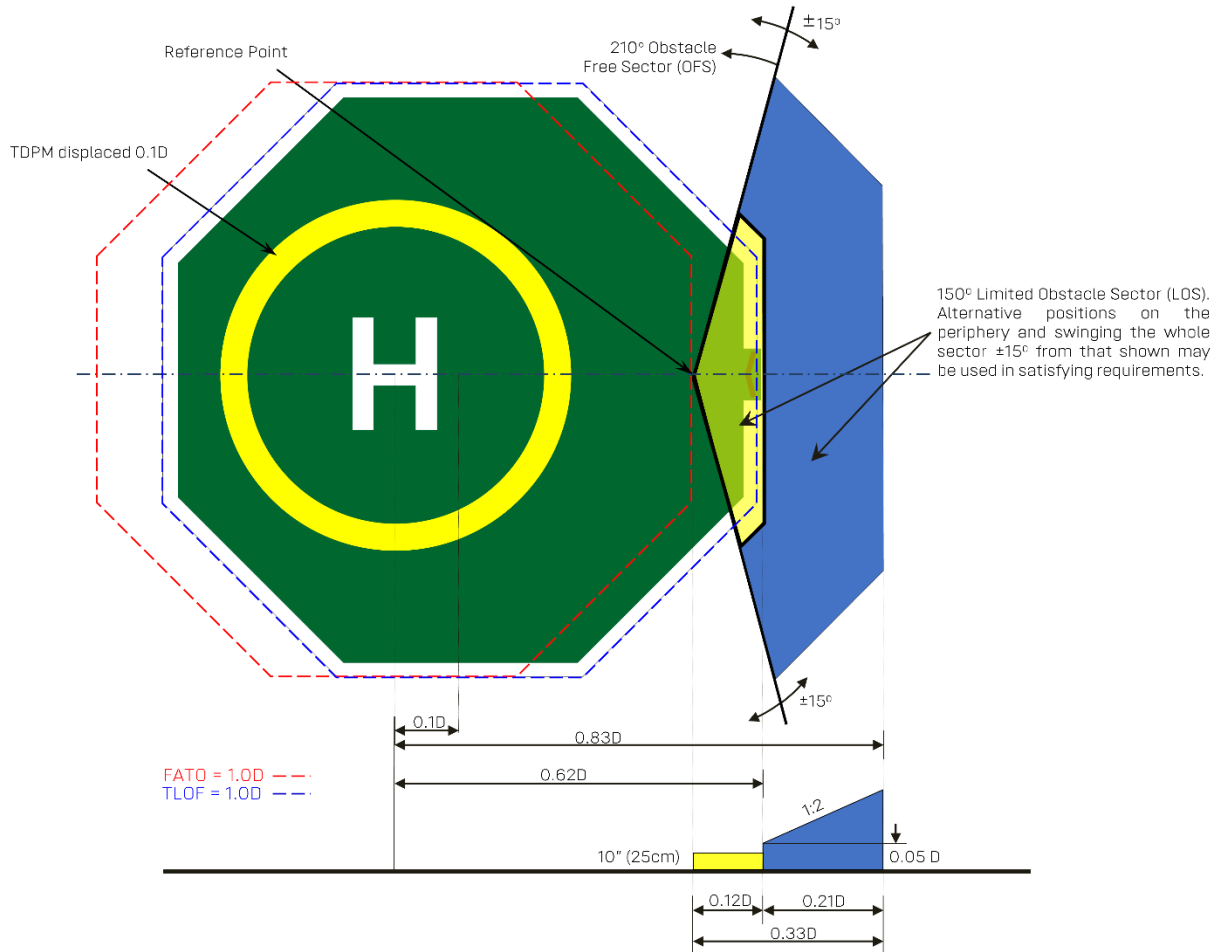

Figure 25: Example of a 0.1D displaced TDPM and 'H' for a helideck with 0.83D TLOF and 1.0D FATO

6.7.1.2 Displacement due to offset TDPM and 'H'

Where displacement of the chevron is caused by a max. 0.1D displacement of the TDPM and 'H' marking on a 1.0D TLOF, this displacement is shown in a similar way as "WARNING DISPLACED CHEVRON +X.X ft. (+Y.Y m)" where X is the displaced distance of the chevron marking outward from the point of origin on the TLOF.

When a TDPM and 'H' marking are displaced (max. 0.1D), the point of origin of the 210 degree OFS also shifts by max. 0.1D. In this case the chevron is still marked on the perimeter line with an additional marking underneath to identify the displacement distance and direction.



Note: Although the first section of the LOS allows for obstacles not exceeding 10" (25cm), there will be a portion of that LOS section that overlaps the TLOF. If objects are required in that overlapping portion over the TLOF, the height above the TLOF surface of those obstacles should be limited to 2 in. (5 cm) (see 4.3.5.2).

Figure 26: Example of a 0.1D displaced TDPM and 'H' for a helideck with 1.0D TLOF and 1.0D FATO

6.7.1.3 Displaced TDPM and 'H' for a less than 1.0D TLOF and 1.0D FATO

Where displacement of the chevron is caused by a max. 0.1D displacement of the TDPM and 'H' marking on a less than 1.0D TLOF, this displacement is shown in a similar way as "WARNING DISPLACED CHEVRON +X.X ft. (+Y.Y m)" where X is the displaced distance of the chevron marking outward from the point of origin on the TLOF.

When a TDPM and 'H' marking are displaced (max. 0.1D), the point of origin of the 210 degree OFS also shifts by max. 0.1D. In this case the chevron is still marked on the perimeter line with an additional marking underneath to identify the displacement distance and direction.

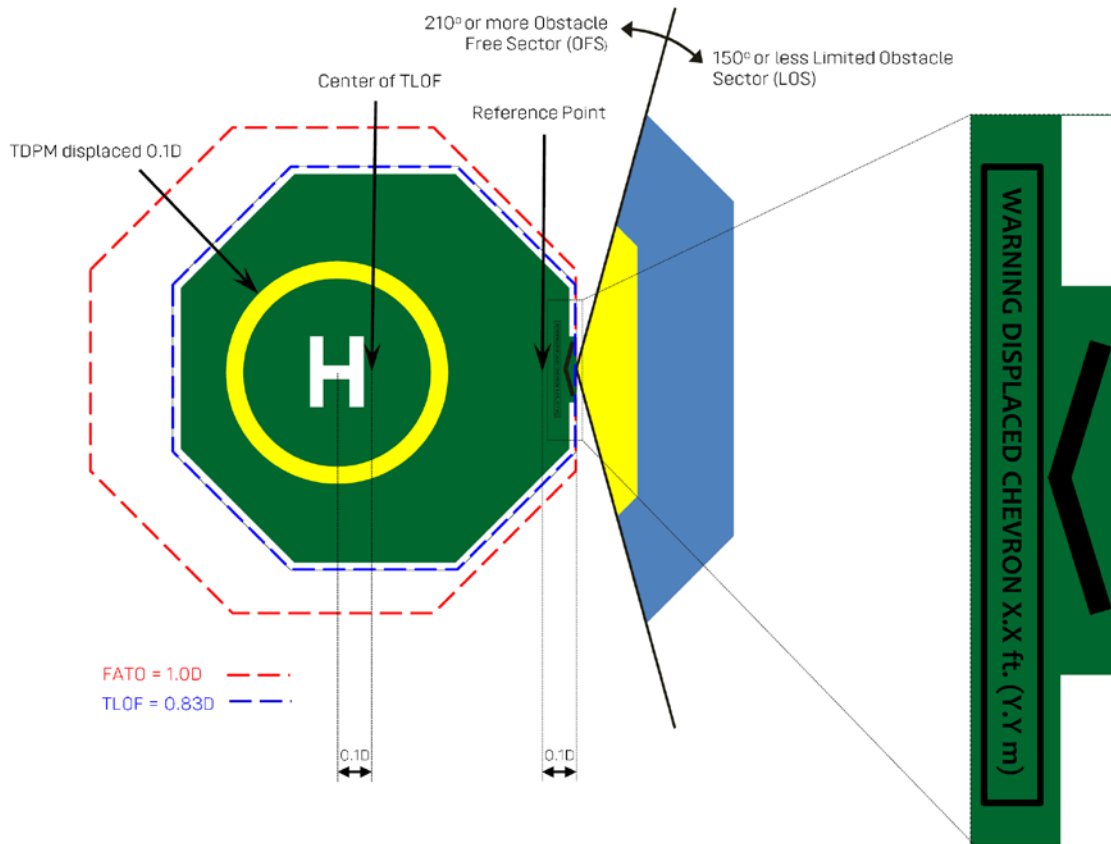

Note: The displacement of the TDPM and 'H' on a less than 1.0D sized helideck will result in reduced space available between the TDPM and the TLOF edge on the opposite side of the chevron marking. This reduced space may not be sufficient to land a helicopter with the nose landing gear in this area while maintaining 3 feet clearance of the nose wheel from the TLOF edge. Additionally, in certain situations this displacement of the TDPM and 'H' will also result in reduced operating space on that side of the helideck for helideck team members and on-boarding/off-boarding activities. These situations shall be risk assessed and could result in the application of a 'NO NOSE' section on the TDPM to restrict certain helicopter headings on the helideck. Any mitigation resulting from the displacement of the TDPM and 'H' shall be documented in the HIP and HOM.

Figure 27: Example of a 0.1D displaced TDPM and 'H' for a helideck with 0.83D TLOF and 1.0D FATO

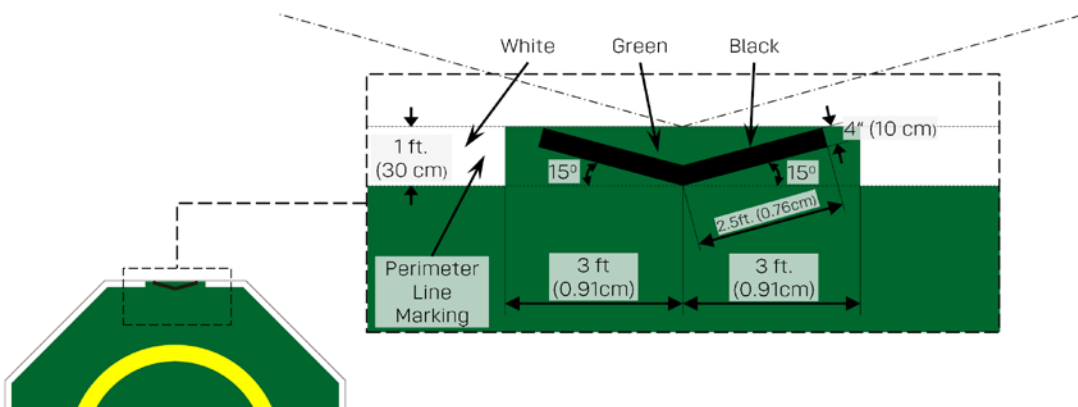

Note 1: Placing the chevron marking on the FATO perimeter line will actually displace the apex of the chevron approximately 1 foot from the outer edge of the FATO perimeter where the reference point of the OFS and LOS actually begins. Thus, the actual placement of allowable obstacles begins at the LOS reference-and not at the apex of the chevron as depicted on the actual LOS chevron marking.

Note 2: The actual OFS reference point/point of origin will in most cases is located on the safety shelf (see Figure 3, Figure 17, and Figure 29).

Figure 28: Chevron marking

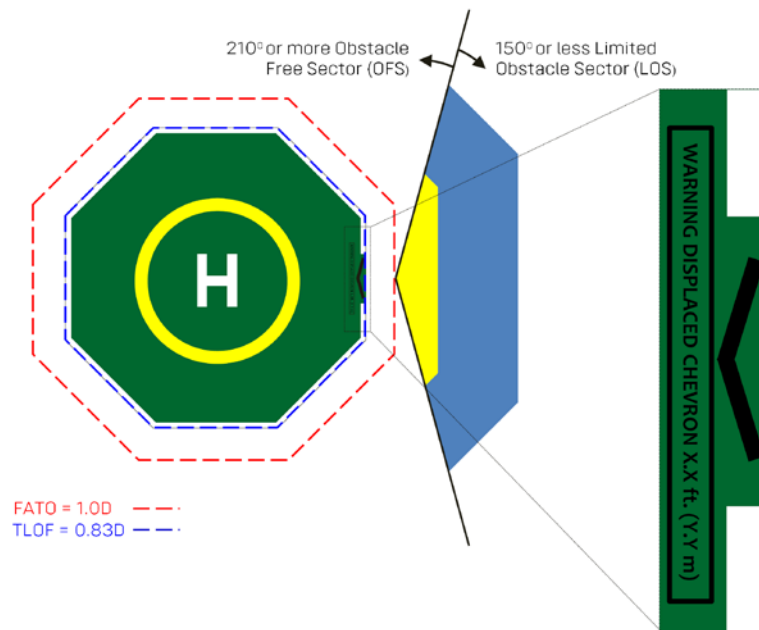

Figure 29: Displaced chevron marking

6.8 Parking Area and Parking Transition Area Markings

The parking area (PA) shall be clearly distinguished from the TLOF surface and surface markings by the use of light gray color on the PA surface. The perimeter of the PA shall be marked with a 12 in. (30 cm) wide solid white line. See 6.12 for information on painting aluminum helidecks.

The parking transition area (PTA) surface shall be painted in a black color, starting from the perimeter line of the TLOF to the PA perimeter line.

Note 1: If a limited parking area (LPA) or push-in parking area (PIPA) is provided, see Annex A for additional marking guidance.

Note 2: For hover transition areas, other methods of movement via ground taxi, push in, etc. are also allowed.

A yellow touchdown parking circle (TDPC) marking shall be marked on PA to provide proper obstacle clearance when the pilot's seat is over the TDPC. The TDPC shall have an inner diameter of $0.5D$, line width of 3 ft. (1 m), and the center of the TDPC shall be located $0.5D$ from the PA perimeter nearest to the TLOF as illustrated in Figure 30. In the center of the TDPC, the words "Parking Area" shall be marked in black as indicated in Figure 30.

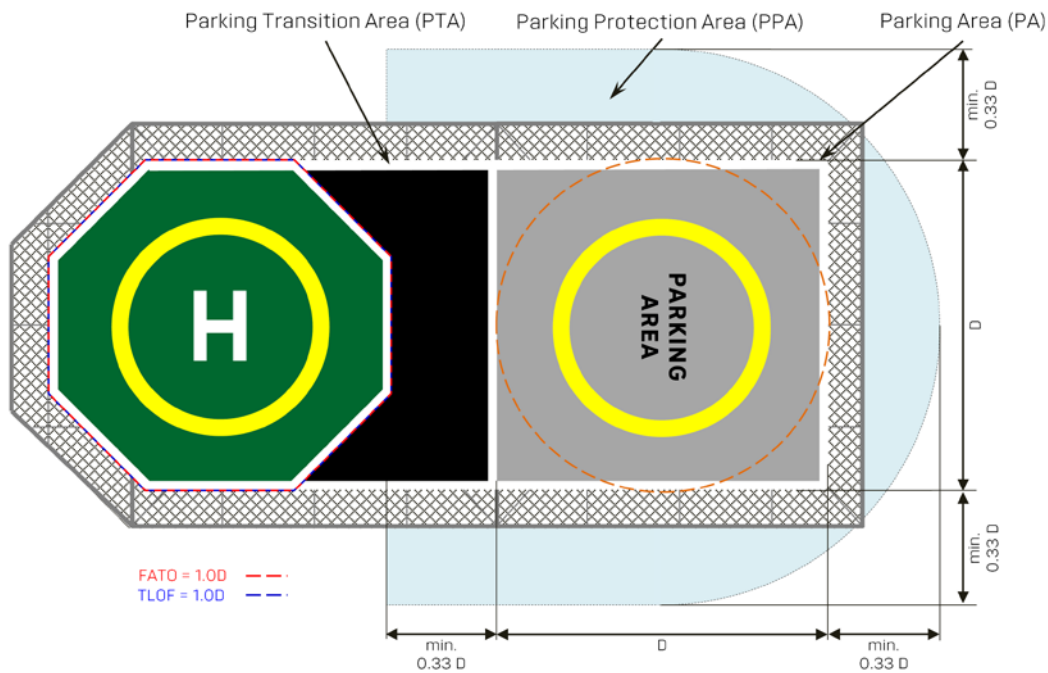

Note: The TLOF weight (mass)/size markings and chevron are not shown in the figure.

Figure 30: Parking Area and Parking Transition Area markings for 1.0D FATO, 1.0 D TLOF, and 1.0D PA

If there are any restrictions to the method of movement from the TLOF to the PA, any other PA restrictions, or if the PA is not designed as previously described, refer to Annex A ([ANNEX A: Guidance for Helideck Limited Parking Areas and Push-in Parking Areas](#)) for further guidance.

For a helideck with a 1.0D TLOF or a 0.83D TLOF and a 1.0D PA with the same weight allowance as the TLOF, no weight (mass) and size markings are necessary for the PTA.

6.9 Prohibited Landing Sector Markings

On a helideck where the number of personnel access points is limited, a “No Nose” prohibited landing heading sector marking may be used to avoid placing the tail rotor in close proximity to the stairs, etc.

The sector of the TDPM, opposite from the personnel access points shall be bordered in the color red, with the words “No Nose” clearly marked in red, on a white background as shown in [Figure 32](#). When positioning over the TDPM, helicopters shall be maneuvered to keep the aircraft nose clear of the “No Nose” marked sector of the TDPM at all times in order to assure required tail rotor clearance on the opposite side of the helideck. The minimum prohibited ‘No Nose’ marking shall be 30°.

6.10 Fixed Obstacle Markings

Fixed obstacles that present a hazard to flight operations shall be readily visible from the air. If a paint scheme is necessary to enhance identification by day, alternate black and white, black and yellow, or red and white bands are recommended, not less than 1.5 ft. (0.5 m) nor more than 20 ft. (6 m) wide. The use of “Day-Glo” orange bands may also be acceptable.

Obstacles to be marked in these contrasting colors include any lattice tower structures and crane booms, in addition to obstacles that are close to the helideck or the LOS boundary. Similarly, parts of the leg or legs of jack-up units adjacent to the helideck area that extend, or can extend, above it should also be marked in the same manner. Lattice towers should be painted in their entirety.

Where obstacles infringing the OFDS have been accepted by the owner and helicopter operator, the white perimeter line shall be overlaid by hatched yellow and black diagonal bands of 8 in. (20 cm) wide to mark the area defining the width of the obstacle below plus 12 in. (30 cm) on each side to indicate to flight crew that an infringement of the OFDS below the helideck is present in that sector and take-off over the marked area should only be performed when safe clearance is guaranteed from obstacles below the helideck in the event of an engine failure for the type of helicopter operated using the approved performance charts in the Ops manual at take-off. See [Figure 31](#) below.

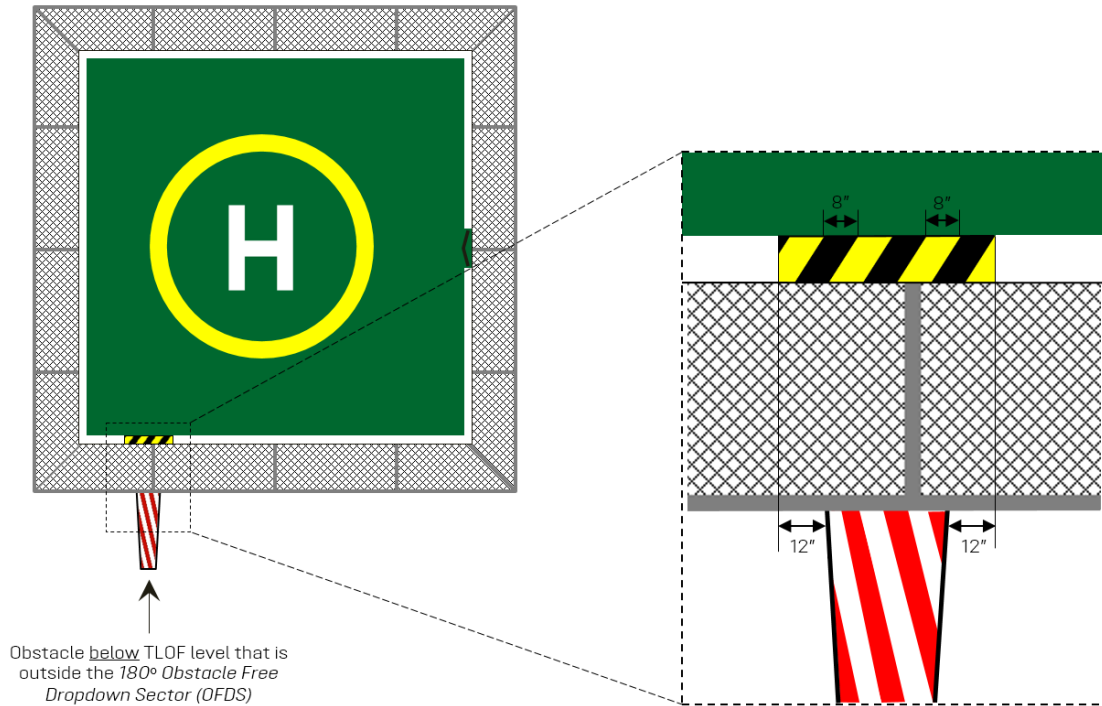

Figure 31: Obstacle Warning Marking for OFDS

Note 1: Alternative conspicuous color paint schemes should be considered for clearly differentiating the vent pipes or flare piping, etc. in the vicinity the helideck from its surroundings/environment, especially on smaller legacy helidecks.

Note 2: Because they are thin and particularly difficult to see, whip antennas should not be placed within 1.5 ft. (5 m) of the edges of the LOS, even if technically they meet the obstacle clearance requirements.

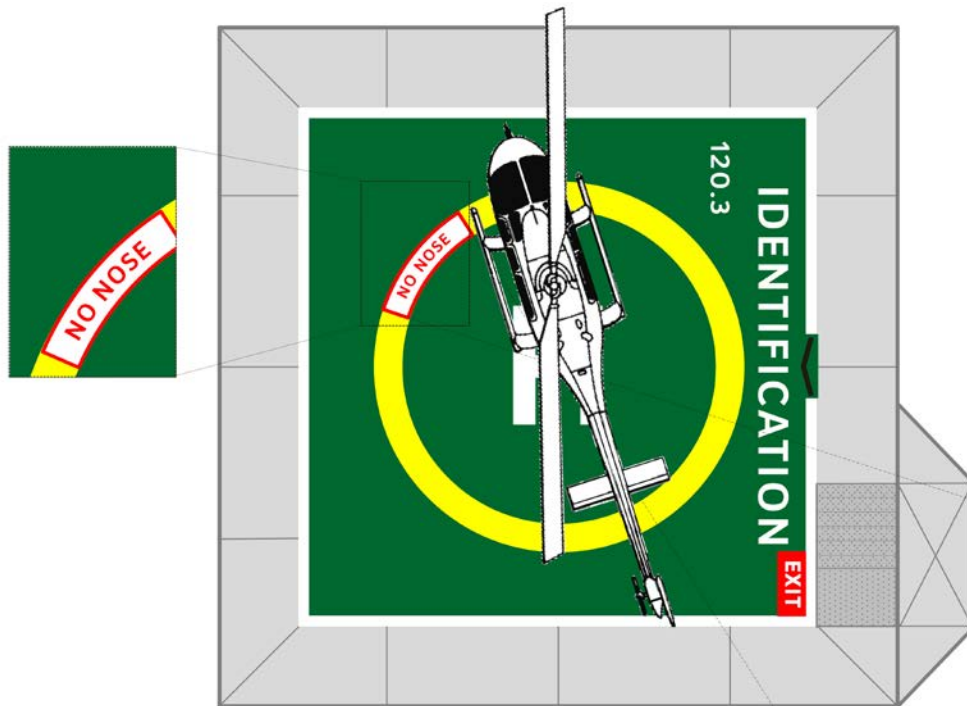

Figure 32: "No Nose" marking

6.11 Helideck Name and Radio Frequency Markings

The TLOF shall be marked with a facility identification (name or block number) marking and radio frequency number. The facility identification (name) shall be marked on the TLOF surface between the perimeter line marking that contains the chevron and the TDPM in white colored letters and/or numbers of not less than 3 ft. (1.0 m) high. The radio frequency shall be marked in the upper left quadrant between identification marking and TDPM in numbers and letters of 2 ft. (0.6 m) and in the same white color as the identification marking as shown in [Figure 20](#) and [Figure 23](#). Identification and radio frequency markings shall have the same orientation for ease of verification during a pre-landing orbit.

6.12 TLOF Surface Colors

The surface bounded by the TLOF perimeter shall be of a dark green color, with a non-skid coating. Where the surface coating may have a degrading effect on friction qualities or is not practical since the surface incorporates for example a fire protection system, it may be necessary to leave the helideck surface untreated. Aluminum helidecks are a natural light grey color and may present painting difficulties. The natural grey color of aluminum is acceptable for the TLOF surface (inclusive of PA and PTA), provided it has sufficient friction and the conspicuity of the markings are enhanced by outlining those markings with black or by overlaying white or yellow markings on a black background. See paragraph [5.5](#) for additional details on painting of aluminum helidecks.

6.13 Exit markings

Regular access/egress points shall be marked as 'EXIT'.

The exit marking shall be identified by a red box against the TLOF side of the perimeter line marking as shown in [Figure 33](#) and [Figure 34](#). This box shall be 4 ft. (1.2 m) wide by 2 ft. (0.6m) high with the word EXIT with 12 in. (30 cm) high white lettering.

Exits that provide egress by ladder, or are not used for regular access, shall be marked as "EMERGENCY EXIT". The emergency exit marking shall be identified by a red box against the TLOF side of the perimeter line marking as shown in [Figure 33](#) and [Figure 34](#). This box shall be 4 ft. (1.2 m) wide by 2 ft. (0.6m) high with the word EMERGENCY above the word EXIT with 6 in. (15 cm) high white lettering.

The reading direction of the EXIT and EMERGENCYEXIT markings shall be such as to provide clear guidance for individuals on the TLOF attempting to locate an egress point.

6.14 Walkway Markings

For minimally manned facilities, a walkway marking is optional. For NUIs, a walkway/direction marking to the exit, see [Figure 34](#), shall be painted on the helideck surface, although it should be noted that this might present a hazard for single egress decks if the pilot is forced by wind direction to land with the tail rotor close to this marked walkway. The walkway markings 3 ft. (1.0 m) wide shall start 1 ft. (30m) from the TDPM and it shall be marked in black.

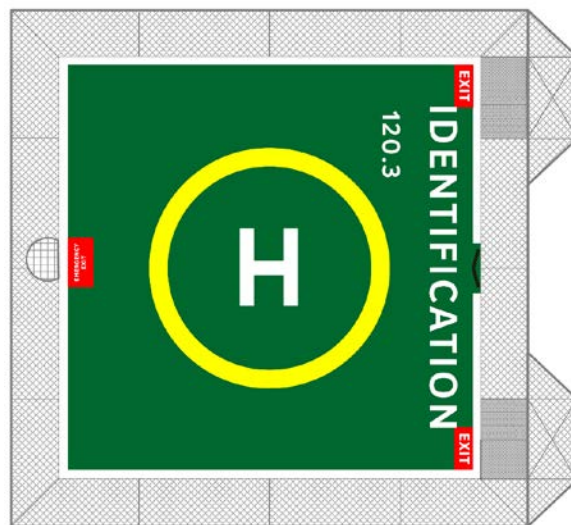

Figure 33: Manned facility Exit marking

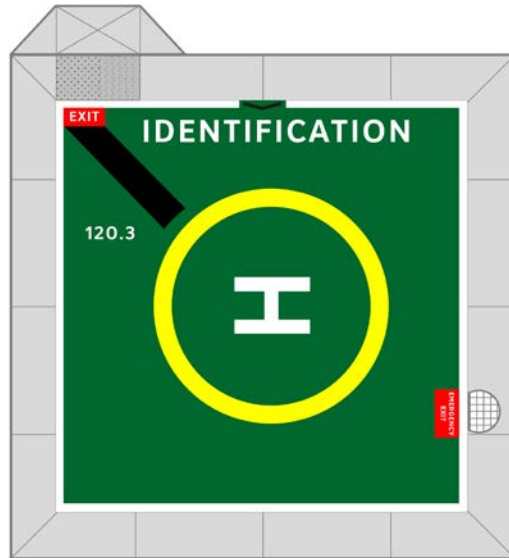

Figure 34: Unmanned facility Exit marking with Walkway marking

7 LIGHTING

7.1 General

Helideck associated lights shall be installed on manned-facilities or other facilities where the possibility of use at night/low ambient light or during instrument flight conditions.

New technology lighting such as strip light emitting diodes (LED) for the TLOF perimeter or TDPM should be considered as these become more available, reliability is proven, and they meet the equivalent lighting specifications for existing lighting systems. Specifically the yellow painted "circle segments" defined within UK CAA CAP 437.

Note 1: The system for securing the LEDs to the TLOF surface shall be carefully reviewed to ensure the method of attachment will not cause damage to the helicopter landing gear.

Note 2: The LED system design shall be reviewed to ensure it will not present a roll over hazard for helicopters in the event the landing gear snags the LED system.

Specifications for perimeter lights for the TLOF, parking area, and parking transition area, are given in Annex E (ANNEX E: Perimeter Light Requirements).

7.2 TLOF Perimeter Lighting

Perimeter lights shall be used to delineate the TLOF. Aviation green omni-directional lights shall be used. The omni-directional perimeter lights shall have an intensity and intensity distribution (beam spread) corresponding to the values defined in FAA Engineering Brief No. 87. See Annex E for additional information on perimeter lighting.

Note 1: FAA Engineering Brief No. 87 applies to heliports but the intensity and intensity distribution (beam spread) requirements are equally applicable to helidecks.

Note 2: The intensity levels required in FAA Engineering Brief No. 87 are lower than ICAO/CAP437 and there is no maximum intensity. Theoretically, a helideck could have very bright lights being used as perimeter lights, this shall be avoided.

The perimeter lights shall be uniformly spaced at intervals of not more than 10 ft. (3.0 m).

For square or rectangular shaped TLOFs, there shall be a minimum number of four lights on each side including one light at each corner as shown in Figure 35. For circular, hexagonal, or octagonal shaped TLOFs, there shall be a minimum of eight lights as shown in Figure 36. For hexagonal or octagonal shaped TLOFs, there shall be at least one light at or near as practicable to each corner and lights between the corners must be equally spaced as in Figure 36.

Perimeter lights shall be outboard and adjacent to the TLOF edge. These lights shall not protrude more than 6 in. (15 cm) above the elevation of the TLOF surface for a 1.0D TLOF or 2 in. (5 cm) for a 0.83D TLOF or any TLOF smaller than 40 ft. For designs where the perimeter lights cannot be outboard and adjacent then they may be mounted on the TLOF perimeter marking but shall be flush mounted.

Note 1: All lighting components and fitment shall meet safety regulations relevant to a helideck environment as prescribed in API 500 or API 505 for lighting requirements, and as a minimum be rated for Class 1, Division 2 (including temperature T4) or IECEx Zone 1 equivalent, in line with US Coast Guard requirements.

Note 2: If night vision goggle (NVG) approaches are anticipated, the lights shall be NVG compatible.

Note 3: Lighting is recommended to have Class Type Product Type Approval. Helideck Owners should be able to present a TA certificate. Additionally have certification and listing to UL 1598A "Luminaries for Installation on Marine Vessels".

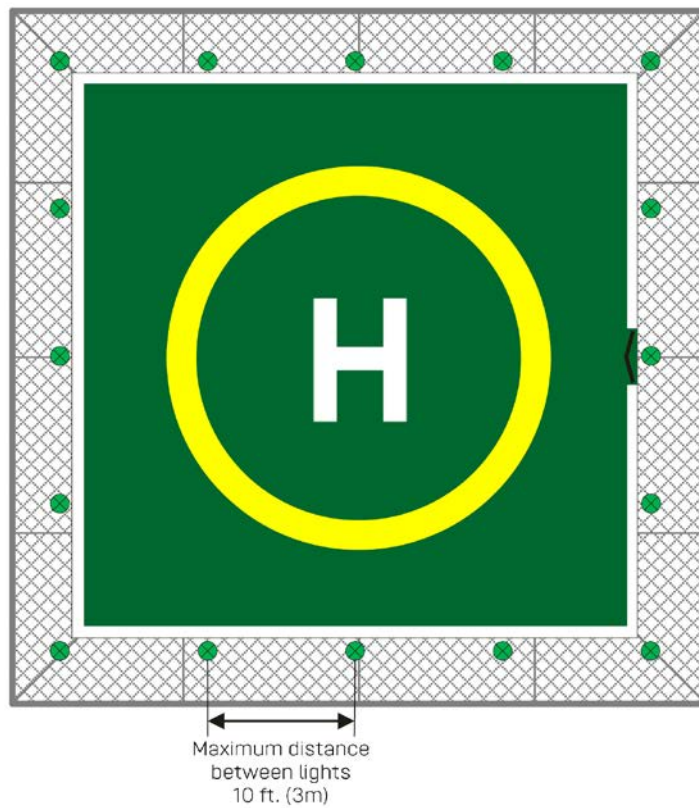

Figure 35: Square shaped TLOF helideck Perimeter Lighting arrangement



Note: Safety net/shelf not depicted.

Figure 36: Octagon shaped TLOF helideck Perimeter Lighting arrangement

7.3 TLOF Flood Lighting

Flood lighting may be required to improve the ability of the pilot to see the TLOF markings (TDPM, 'H', size/weight (mass) limits) during approach and landing and to illuminate the TLOF and surrounding area for helideck "ground" operations (passenger movements, refueling operations, freight handling etc.), Figure 37 below provides a typical flood lighting arrangement.

For helideck ground operations, it may be possible to site additional high-mounted flood lighting away from the TLOF perimeter, such as on nearby structure outside the LOS. This additional flood lighting shall not cause a source of glare to a pilot, especially when lifting in the hover to transition into forward flight, and shall not present a competing source to the green TLOF perimeter lights.

Note: When floodlights are provided solely for ground handling reasons or parking areas they shall be capable of being switched off during landing and takeoff of the helicopter.

Between 4 and 6 floodlights should be sufficient for most smaller helidecks. In the case of a helideck with a parking area lighting as shown in Figure 38, 3 lights around the perimeter may be used.

To mitigate glare, floodlights shall be mounted so that the centerline of the floodlight beam is at an angle of 45 degrees to the reciprocal of the prevailing wind direction. The height of the installed TLOF floodlights shall not exceed the heights prescribed in 4.3.5.2.

The spectral distribution of TLOF area floodlights shall ensure adequate illumination of the surface markings (especially the touchdown/ positioning marking), the helideck name, and any obstacle markings.

Adequate shielding shall be used on any flood lighting that could dazzle or disorientate the pilot during an approach for landing and the arrangement/aiming of flood lights shall be such that shadows are kept to a minimum

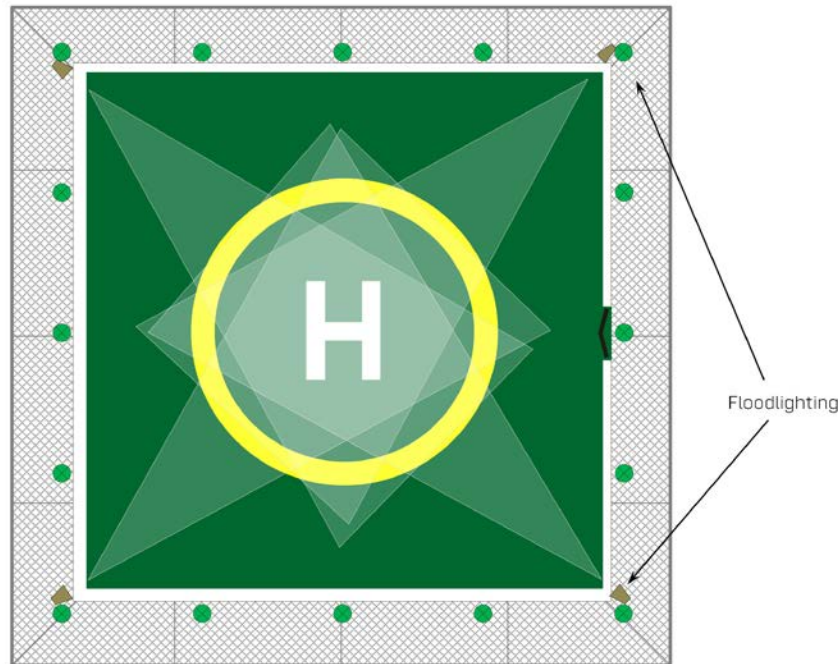

Figure 37: Typical Floodlighting arrangement

7.4 Parking Area and Parking Transition Area Lights

The specifications depicted for TLOF perimeter lights in paragraph 7.1 could also be used for the parking area perimeter and parking transition area, but the color of the lights shall be aviation blue; however, TLOF perimeter lights are designed to allow them to be seen from distance. As the blue parking area lights are only required to be seen for parking, the intensity and beam pattern can be reduced.

Note: LED technology needed to match the intensity and beam angles of green TLOF perimeter lights regarding the design, size, and power supply for blue parking area lights will result in significantly larger light fittings. Reduced intensity and alternative beam patterns can accommodate downsizing the design of LED light fixtures for blue parking area and PTA lighting arrangements.

The blue lights on the inboard section of the parking transition area and parking area shall be flush mounted as shown in Figure 38.

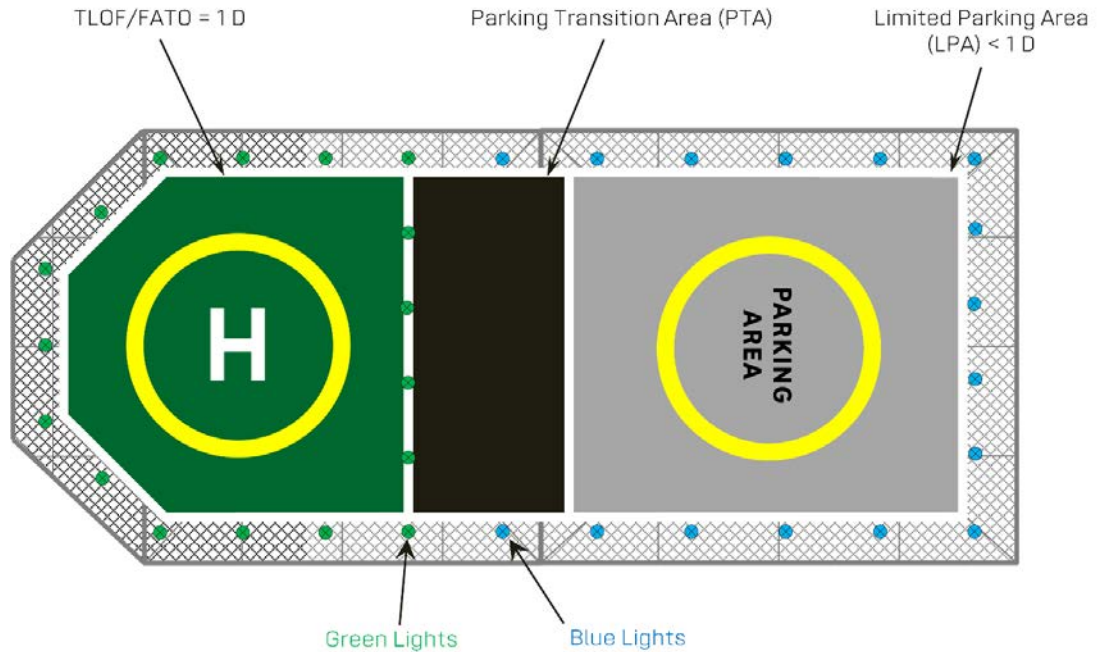

Figure 38: Parking Area lighting arrangement

Note: FAA Engineering Brief No. 87 only refers to 'aviation green lights': the intensity and intensity distribution (beam spread) is applicable to aviation blue lights.

7.5 Helideck Status Light(s)

The intent of the status light(s) is to indicate an unsafe landing area. Red flashing helideck status light(s) shall be provided for all manned facilities. The helideck status light(s) are turned OFF after the helideck and environment have been checked and considered safe for flight operations by a competent Helicopter Landing Officer (HLO). The illumination of a helideck status light (ON) indicates the helideck is closed to helicopter operations.

The status light(s) shall be located to be visible by the pilot from all approach directions, i.e. 360° in azimuth and any orientation of a helicopter on the helideck. A standard configuration of Helideck Status Lights therefore consists of a minimum of two lights. The light(s) shall not exceed the specified height restrictions in paragraph 4.3.5.2 (OFS) unless located in the LOS and not exceeding the obstacle height limitations in that sector (see paragraph 4.3.5.4(LOS)).

Note: Document UK CAA CAP 437 provides detailed specifications and should be used as reference document for additional information.

Helideck Status Light(s) shall also be operating during conditions hazardous to helicopter operations (like hot air, raw gas, H₂S, etc.) as listed in section 7.5), and shall be automatically triggered and remain on until the hazard is cleared. Additionally, the helideck status light shall be left ON and flashing in the manual mode at all other times until the helideck and environment has been checked and considered safe for flight operations by a competent HLO. Examples of these hazardous situations include but are not limited to the following: Facility not prepared to accept helicopter operations, Crane operations, Helicopter Landing Officer (HLO) has not provided a Green Deck, Wind conditions exceed helicopter limitations, etc.). Installation of an additional H₂S specific horn unit near the helideck should be considered for the purpose of alerting helicopter crew in cases where H₂S gas is present on or around the helideck.

Note: Installed horn unit(s) shall not exceed the height limitations as shown in paragraph 4.3.5.

The effective intensity of the status light shall be a minimum of 700 cd between 2° and 10° above the horizontal and at least 176 cd at all other angles of elevation. Back-up lights shall be provided in the event of failure of the primary status light(s). The flashing status light(s) shall have a minimum flash rate of 120 flashes per minute, and where multiple lights are installed the lights shall flash in an alternating pattern to increase visual cueing for flight crews.

Note: Where one light/automated activation system can be technically designed to perform all the functions required one status light could be used.

7.6 Lighting of Obstructions

Elevated obstructions that are not clearly visible shall be marked with omni-directional red lights of at least 32.5 cd. Where the highest point on the facility exceeds the elevation of the TLOF by more than 50 ft. (15 m), an omni-directional red light shall be fitted at that position, with additional lights fitted at 35 ft. (10 m) intervals down to the elevation of the TLOF.

Specifications for obstruction lights (low intensity type L-810) are given in FAA Specification for Obstruction Lighting Equipment, FAA Advisory Circular 150/5345-43J.

Note: Flood lighting of obstacles at night is allowed in situations where a facility with a helideck has obstacles that cannot be fitted with or where it is not practicable to fit obstacle lights. Floodlights shall be positioned in a way to avoid glare for flight crewmembers.

7.7 Uninterruptible Power Supply (UPS)

Arrangements shall be made so that there is no loss of critical (specified) lighting due to loss of the primary power system on the facility.

Note: A critical lighting analysis shall require at least 50 % of perimeter lighting and 100% of the access and egress routes, obstruction, status lights, and windsock lights to remain operational.

This lighting power may be supplied from the emergency generator/power bus so lighting is maintained, and be provided from an UPS sufficient to power the specified lighting for the period required for the emergency generator/bus to assume the load after the loss of primary power.

In the event that the facility is not equipped with an emergency generator/bus as noted above, the specified lighting shall be connected to a UPS capable of powering the lighting for a period of at least 18 hours.

8 FUELING STATIONS

8.1 General

Helicopter fueling stations and equipment shall be located to avoid obstructing any personnel access or egress route serving the TLOF (helicopter flight deck) and shall not infringe required obstacle-free surfaces.

Piping for fuel systems shall be stainless steel with welded connections. All tanks, sumps, and filtration unit shall have low point drains for the removal of contaminants.

Note: HSAC RP Number: 163 provides design guidance and design checklists fuel systems (10.7 and Appendix 4 with Attachments 4 and 7)

8.2 Fuel Tanks

Fuel storage tanks shall be installed as far as practicable from the TLOF area, accommodation spaces, escape routes, embarkation stations, and sources of vapor ignition. Marine portable fuel storage tanks must meet the requirements 46 CFR Part 64 and each marine portable fuel storage tank must have a means to contain fuel spills or leaks. All steel tanks shall be lined with an approved epoxy liner unless the tanks are constructed of stainless steel and the tank design shall incorporate a floating suction.

8.3 Fuel Transfer Equipment

All fuel delivery systems, including portable systems, shall be fitted with water blocking (i.e. a system designed to stop fuel flow from the fuel delivery when water contamination is present in the filtration shall meet the requirements of EI 1550) both into and out of the storage tank.

Each nozzle must be a dead man type resulting in the stopping of fuel flow when released. Each hose shall have a storage reel meeting the requirements of EI 1529. A Static bonding cable, which attaches to the aircraft and the fueling nozzle, shall be provided.

Each electric fuel transfer pump must have a control with a fuel transfer pump-operation-indicator light at the pump. There must be a fuel pump shut off at each of the helideck access routes. Each tank, pump unit, filter, each hose reel must have a means to contain fuel spills or leaks

All components of the fuel system shall be electrically bonded. Each hose shall meet the requirements of NFPA 407, Chapter 3.

8.4 Marking of Fuel Systems

Required markings shall be applied during system manufacture as prescribed in EI 1542. Each helicopter fueling facility shall be marked adjacent to the fueling hose storage: "WARNING - HELICOPTER FUELING STATION - KEEP LIGHTS AND FIRE AWAY". Additionally, each storage tank for helicopter fuel shall be marked: "DANGER - FLAMMABLE LIQUID". Each marking required by this section shall be in letters at least 7.5 centimeters (3 inches) high.

9 WEATHER REPORTING EQUIPMENT

9.1 Windsock

An offshore facility shall be equipped with at least one windsock to provide a visual indication of the wind conditions prevailing over the facility during helicopter operations. The location of the primary wind direction indicator shall be in an undisturbed air-stream avoiding any effects caused by nearby structures, and unaffected by rotor downwash from the helicopter. The location of the windsock shall not compromise the established obstacle protected surfaces.

The windsock shall be easy visible to the pilot on the approach (at a height of at least 600 ft. (200 m), in the hover and whilst touched down on the surface of the TLOF, and prior to take-off. Where these operational objectives cannot be fully achieved by the use of a single windsock, consideration should be given to locating a second windsock in the vicinity of the helideck, which could also be used to indicate a specific difference between the local wind over the TLOF and the free stream wind at the installation (which the pilot will reference for an approach).

A windsock made of orange color fabric shall be illuminated internally or by external lights where night flights are anticipated. This windsock lighting shall not be a glare hazard to pilots. A windsock shall be a truncated cone made of lightweight (mass) fabric and shall have the following minimum dimensions: length 4 ft. (1.2 m), diameter (larger end) 14 in. (0.3 m) and diameter (smaller end) 8 in. (0.15 m).

9.2 Weather Measuring Equipment

In addition to the windsock outlined in 9.1, a manned facility designed for visual flight rule and day only operations shall be minimally equipped with a weather station with the following:

- a) Wind speed, direction and gust spread;
- b) Temperature;
- c) Barometric pressure;
- d) A means to provide cloud ceiling height and visibility which may be estimated visually or by using measurement equipment; and
- e) The ability to report sea state, which may be estimated visually or acquired using wave measurement equipment.

For facilities where instrument flight rules (IFR) or night operations are to be conducted, the weather station must provide all the items in a) through e) above and in addition dew point.

Note: For instrument operations, the weather systems must be certified, calibrated, and maintained as required by the manufacturer or authority and automated systems preferred.

Where an existing manned facility is in close proximity to the planned new manned facility ('close' as determined by regulatory authority) it may be deemed that the new facility does not have to provide the above equipment, provided those existing facilities which are equipped can share their information routinely to

the new facilities. For these new facilities, a manual means of verifying and updating the visual elements of an observation, i.e. cloud amount and height of base, visibility, and present weather, may be used.

Additional guidance relating to the provision of meteorological information from offshore facilities is contained in ICAO Annex 3.

9.3 Floating Facilities Additional Weather Reporting Equipment and Systems

Floating installations experience dynamic motions due to wave action that can present a potential hazard to helicopter operations. Operational limitations are therefore set by the helicopter operators, which are promulgated in the facility's helideck operations manual when the helideck is commissioned and incorporated in the helicopter operator's operations manuals.

Floating helidecks will have limitations established regarding the movement of the helideck in pitch and roll, helideck inclination, significant heave rate (SHR) and facility heading (if applicable) and this information will be recorded by the vessel's helideck monitoring or motion system (HMS) and be available as part of the overall facility offshore weather reporting system.

The accelerometers for such measurements shall be located as close to helideck level and centerline as possible to provide accurate readings. The accelerometer readings may be processed by sophisticated software that can produce accurate helideck level measurements of pitch, roll, and heave (PRH) regardless of the accelerometer location.

Pitch and roll reports to helicopters shall include values, in degrees, about both axes for the true vertical datum (i.e. relative to the true horizon) and be expressed in relation to the vessel's heading. Roll shall be expressed in terms of "left" and "right" in degrees; pitch shall be expressed in terms of 'up' and 'down' in feet or meters (as applicable); helideck inclination is the angle measured in degrees between the absolute horizon and the plane of the helideck. SHR, being twice the root mean square (RMS) heave rate measured over a 20-minute period, shall be reported in meters or feet (as applicable) per second. Values of pitch and roll, helideck inclination and SHR shall be reported to one decimal place.

10 EMERGENCY RESPONSE EQUIPMENT

Equipment shall be immediately available in a weatherproof container to respond to a helicopter mishap on the helideck at a manned facility. (See HSAC RP Number: 163 Chapter 11)

11 COMMUNICATIONS EQUIPMENT

All manned offshore facilities shall have an Aviation VHF radio capable of communicating with the pilots during any flight operation.

ANNEX A: GUIDANCE FOR HELIDECK LIMITED PARKING AREAS AND PUSH-IN PARKING AREAS

12.1 General

If a parking area of 1.0D cannot be provided due to space or structural limitations, a limited parking area (LPA) or push-in parking area (PIPA) outlined in this Annex may be provided. As the parking area discussed in 4.3.4, the limited parking area or push-in area shall be located outside the obstacle-free sector (OFS) and outside the limited obstacle sector (LOS) of the helideck so that a helicopter parked on the LPA or PIPA is outside the LOS height limitations as shown in Figure 39.

12.2 Limited Parking Area

An LPA may be provided when a 1.0D parking area (see 4.3.4) cannot be provided because one or more of the following conditions exists:

- a) an infringement of the 0.33D protection area surrounding the D-circle of the parking area is present;
- b) a weight (mass) limitation exists for helicopters allowed onto the LPA due to structural constraints;
- c) the dimensions of the LPA are insufficient to accommodate the helicopter type allowed onto the TLOF.

The minimum LPA shall be of sufficient size to contain a circle of diameter of not less than 0.83D of the largest helicopter the parking area is intended to serve, surrounded by a 0.33D protection area. Infringements of the 0.33D additional protection area are allowed if be adequately marked and written documentation and procedures are made available to air operators to identify obstruction(s) or limitation(s).

A helideck layout with a 1.0D TLOF and adjacent 0.83D parking area¹ with an obstacle clearance area of 1.0D and a 0.33D parking protection area (PPA) is shown in Figure 39. The TDPC on the (L)PA may be offset to a maximum distance of 0.33D provided the 0.33D clearance is still guaranteed and no part of the helicopter undercarriage is closer than 3 ft. (0.9 m) from the (L)PA deck edge (see Figure 39 for offset diagram example, and Figure 48, Figure 49 and Figure 50 for depiction of the undercarriage 3 ft. helideck edge clearance requirement).

The LPA area may contain objects whose presence is essential for the safe operation of the helicopter with a maximum height of 2 in. (5 cm).

An LPA may be downsized to accommodate a helicopter with a lesser D-value then associated with the TLOF in order to achieve the 1.0D obstacle clearance area and 0.33D PPA for the smaller helicopter. In this case, the D-value of the LPA shall be marked in the PTA together with the weight (mass) limit and the LPA dimension(s), if applicable (see 6.8).

¹ 0.83D = Approximately 1.0 RD

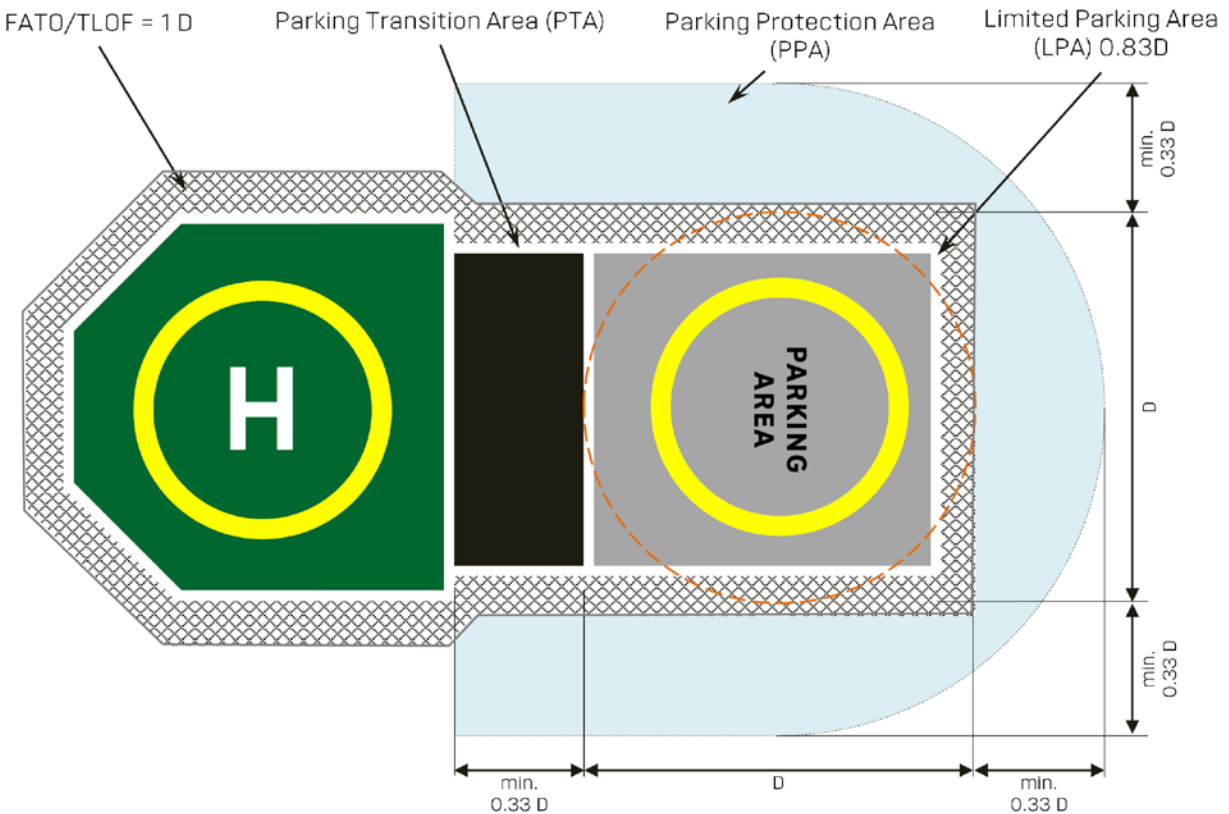

Figure 39: 1.0D FATO, 1.0D TLOF, and Limited Parking Area of 0.83D (RD)

The PTA is an area between the TLOF and the LPA/PIPA used to transition the helicopter to/from the parking area by hover, ground taxi, or ground handling. The PTA divides the TLOF and LPA/PIPA in order to provide a minimum of 0.33D clearance between the parked helicopter and the TLOF perimeter. The PTA surface shall be painted in a black color, starting from the perimeter line of the TLOF to the LPA/PIPA perimeter line. The minimum distance from the 1.0D circle to the LPA/PIPA shall be 0.33D. Thus, the parking area shall be separated from a 1.0D TLOF by a parking transition area (PTA) with a minimum width of 0.33D (see Figure 39) and from a 0.83D TLOF by a minimum width of 0.415D.

Restrictions on the method of transition and any parking area restrictions shall be marked on the PTA (see Figure 51). PTAs, (L)PAs and PIPAs shall be surrounded with a safety net or shelf.

Note 1: During normal operations, no part of either a helicopter tied down or operating on the helideck shall intrude into the PTA except during transition to and from the LPA/PIPA.

12.3 Touchdown Parking Circle Marking

A touchdown-parking circle (TDPC) shall be marked on a(n) (L)PA to provide proper obstacle clearance when the pilot's seat is over the yellow portion of the TDPC. The TDPC shall have an inner diameter of 0.5D,

line width of 3 ft. (1 m), and the center of the TDPC shall be located 0.5D from the (L)PA perimeter nearest to the TLOF.

12.4 Parking Area Markings

12.4.1 General

As indicated in 12.4.2 and 12.4.3, there are two parking circle markings, which may be added to the TDPC to provide clearances from obstacles that may be adjacent to the parking area.

12.4.2 Parking Circle Orientation Marking

The parking circle orientation marking (PCOM) shall be a white colored marking on the yellow TDPC as shown in Figure 40.

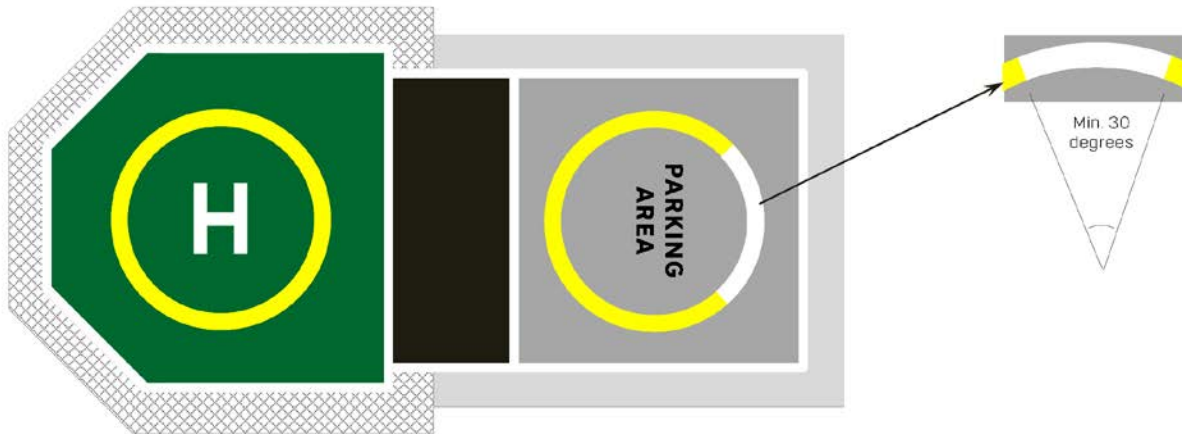

Figure 40: Touchdown Parking Circle (TDPC) marking and Parking Circle Orientation Marking (PCOM)

A parking orientation restriction due to an infringement of a clearance area shall be marked with a Parking Circle Orientation Marking (PCOM). The PCOM is located on the TDPC and provides visual cues to the flight crew that the helicopter needs to be oriented in specific directions before helicopter shutdown (see Figure 41 and Figure 42).

Note: A PCOM is only required if there is an infringement of the 0.33D PPA.

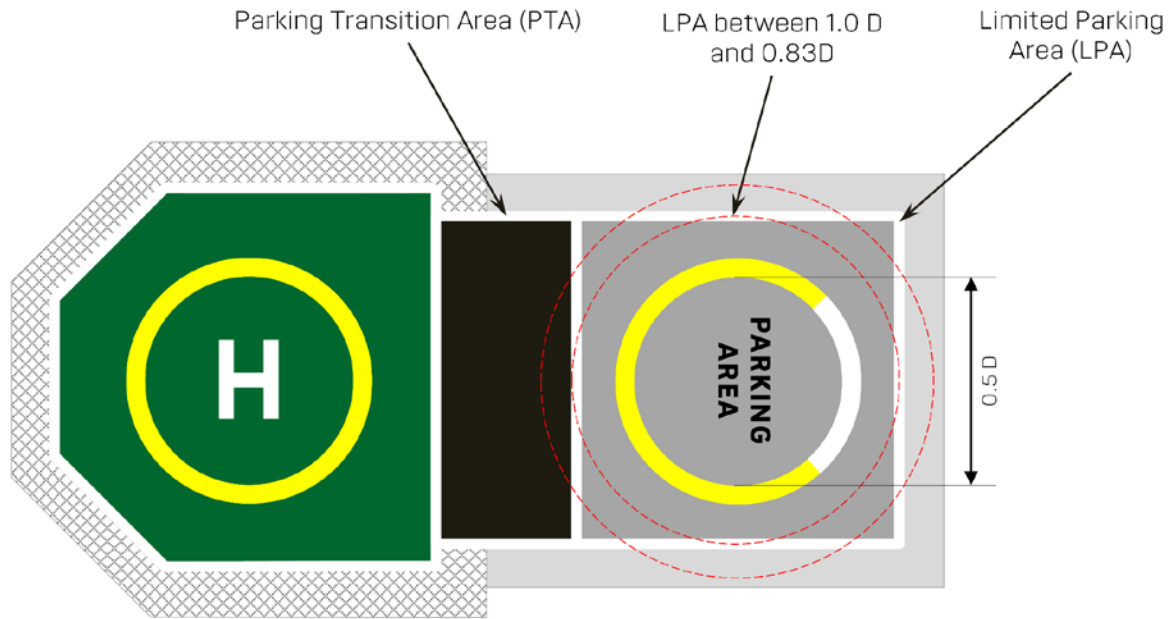

Figure 41: Limited Parking Area (LPA) of 0.83D with Parking Circle Orientation Marking (PCOM)

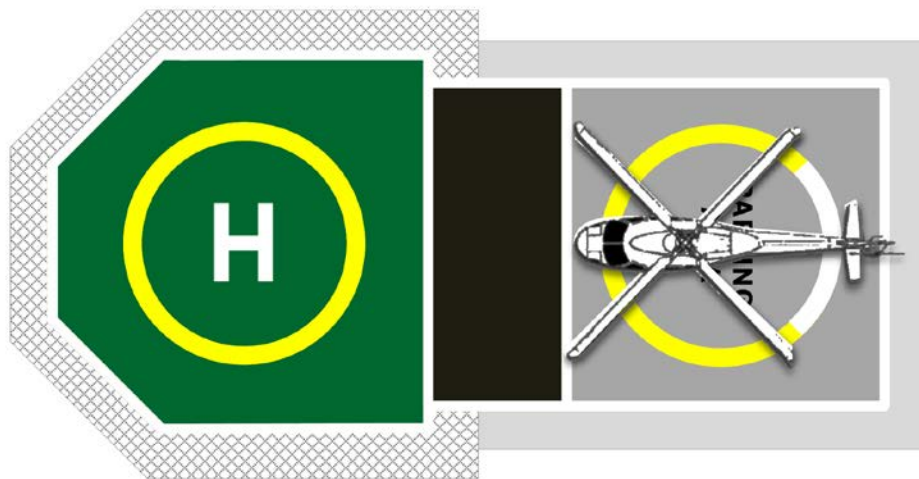

Figure 42: Helicopter parked using Parking Circle Orientation Marking (PCOM)

The nose of the helicopter shall be located over the yellow portion of the circle during or while shutdown as shown in Figure 42.

Maneuvering in the LPA, using hover or ground taxi, is acceptable. The nose of the helicopter shall be located over the yellow portion of the TDPC circle when shutdown i.e. the nose of the helicopter shall not

be located over the white portion of the PCOM circle during or while shutdown. A PCOM marking may be used to avoid the tail rotor being positioned near an exit or emergency exit.

The size of the PCOM will depend on the size of the obstacle to be avoided but when used. It is recommended the minimum (angular) size shall be 30°.

Note: The PCOM provides visual cues to the flight crew that the helicopter needs to be re-oriented before the helicopter is shutdown.

Figure 41 shows a helideck layout with adjacent 0.83D parking area, 1.0D obstacle clearance, and 0.33D PPA. The PCOM provides orientation information that prevents a helicopter's tail rotor from being positioned in the parking transition area and infringing on the 0.33D PPA from the TLOF, which would limit the use of the TLOF.

12.4.3 'No Nose' Marking

A 'No Nose' marking can be used to avoid the tail rotor being positioned near an exit, emergency exit (see 6.13), or if an obstacle is very near to, or infringes, the 0.33D PPA.

A 'No Nose' marking provides visual cues that the helicopter's nose shall not be parked or maneuvered in a particular direction. Figure 43 through Figure 47 show a helicopter maneuvering restriction and a parking orientation restriction, to avoid infringement of the transition area by use of the PCOM marking and use of the No Nose marking to avoid a tail rotor hazard.

A 'No Nose' marking shall be on a white background with a red border and the words "No Nose" located on the TDPC. The 'No Nose' marking section on a TDPC shall be a minimum of 30° but may be expanded depending on the size of the obstacle. One or multiple obstacles may be covered by this sector.

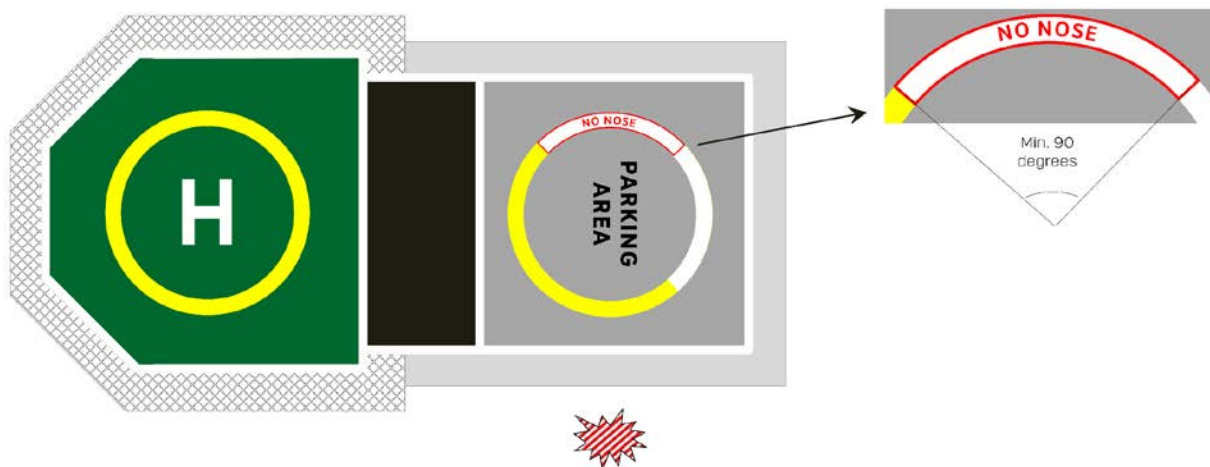

Figure 43: 'No Nose' marking and Parking Circle Orientation Marking (PCOM) on TDPC

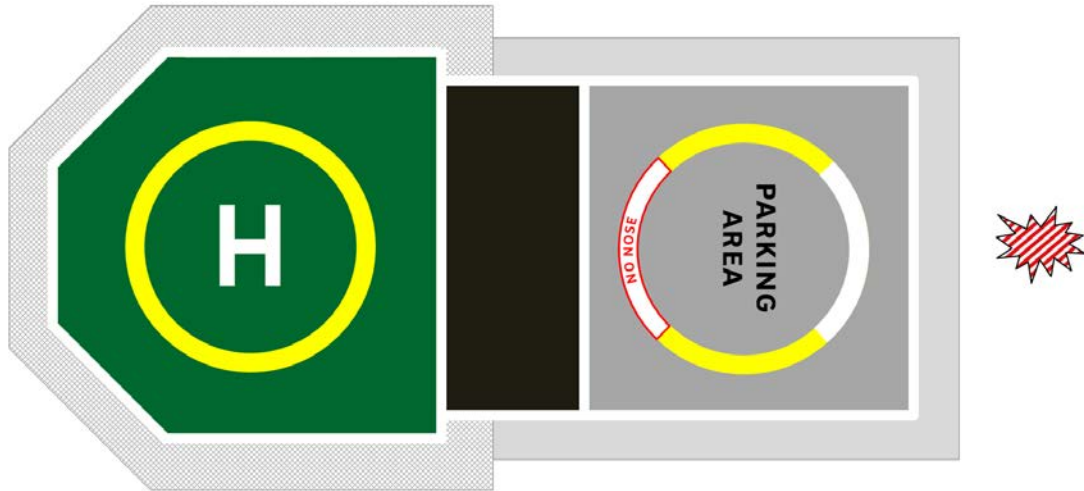

Figure 44: 'No Nose' marking and PCOM on TDPC

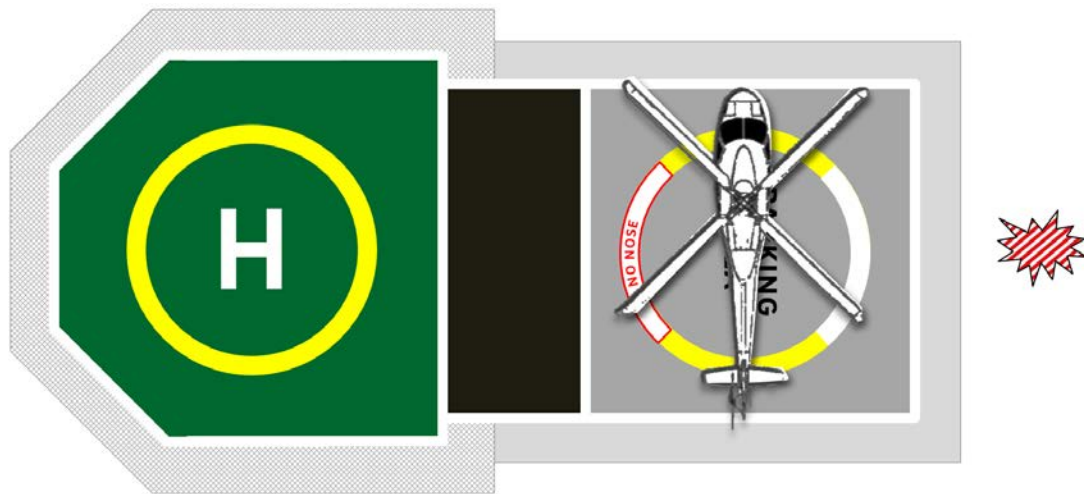

Figure 45: 'No Nose' marking and PCOM on TDPC with parked helicopter

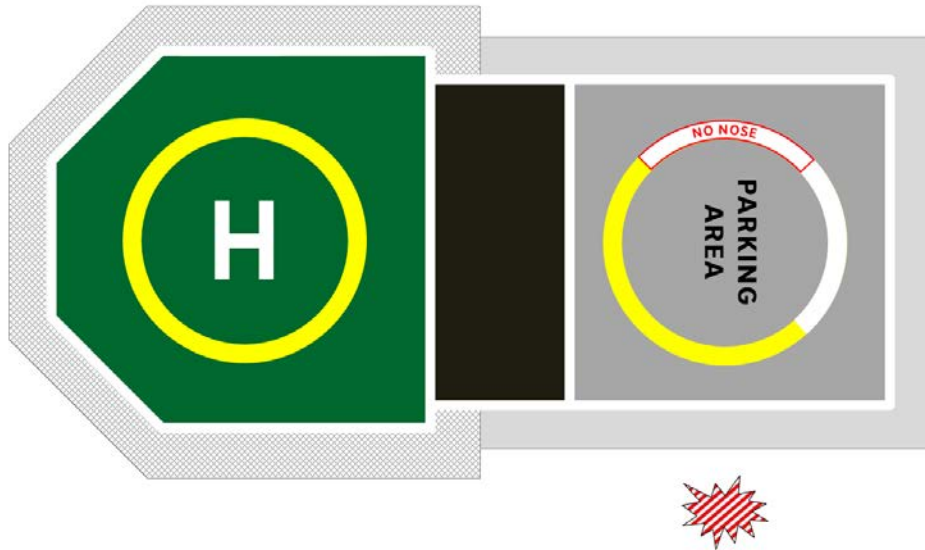

Figure 46: 'No Nose' marking and PCOM on TDPC

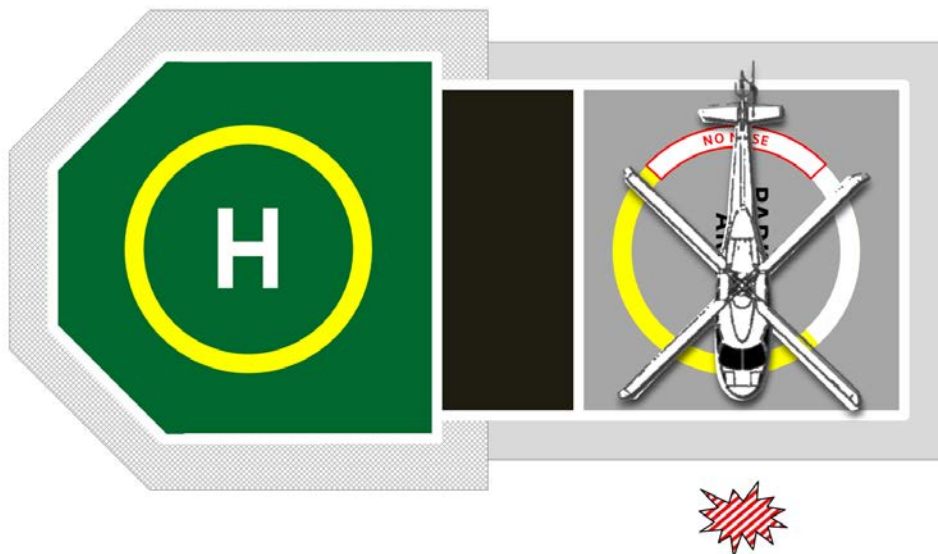

Figure 47: 'No Nose' marking and PCOM on TDPC with parked helicopter

The size of the 'No Nose' marking will depend on the size of the area or obstacle to be avoided by the tail rotor/tail boom. It is recommended the minimum (angular) size shall be 30°.

When positioning over the TDPC, helicopters shall be maneuvered to keep the aircraft nose clear of the "No Nose" marked sector of the TDPC at all times.

12.4.4 Limited Parking Area and Push-in Parking Area Markings

12.4.4.1 General

Information on the markings required on the parking transition area (PTA) for a limited parking area (LPA) and push-in parking area (PIPA) are given in Figure 48. The "PARKING AREA" marking shall be 24 in. (60 cm) high letters black in color. The words shall be stacked and centered within the touchdown-parking circle (TDPC) as illustrated in Figure 39 through Figure 47.

A PIPA will not have a parking circle and the lettering will be a minimum of 12 in. (30 cm) high letters white in color with a 4 in. (10 cm) brush stroke and a 1.5 in. (4 cm) black outline stating "PUSH-IN AREA". The words shall be stacked as illustrated in Figure 48.

12.4.4.2 Push-in Parking Area

The push-in parking area (PIPA) shall be a minimum area that will provide safe ground handling of shutdown helicopters (rotors not turning) to and from the TLOF and the PIPA.

The ability of maintenance personnel to access the helicopter, i.e. work stands, ladders, tools, and equipment should be considered when determining the overall size of the push-in parking area. Illustrations of possible push-in parking areas (PIPAs) are shown in Figure 48 through Figure 50.

A 3 ft. (0.9 m) wide, solid white edge (buffer) line shall be painted along all three free sides of a push-in parking area and sides of the parking transition area (PTA), to aid ground handlers in safely moving the aircraft, while keeping the landing gear (under carriage) at least 3 ft. (0.9 m) inside of the edge of the PIPA. See Figure 48 through Figure 50.

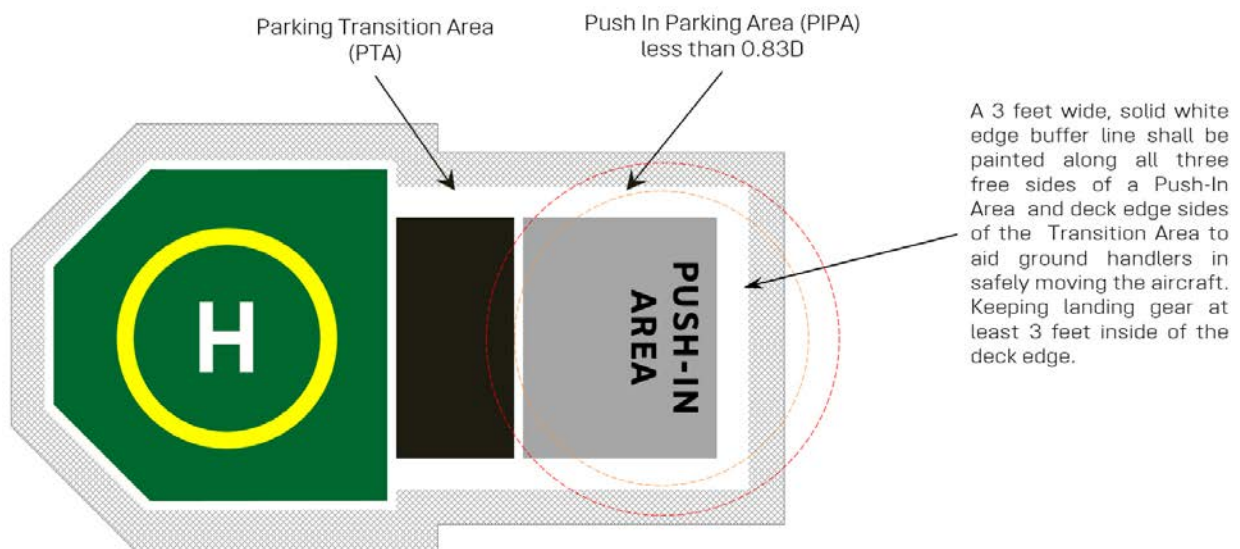

Figure 48: Push-In Parking Area (PIPA)



Figure 49: Push-In Parking Area (PIPA) with parked helicopter

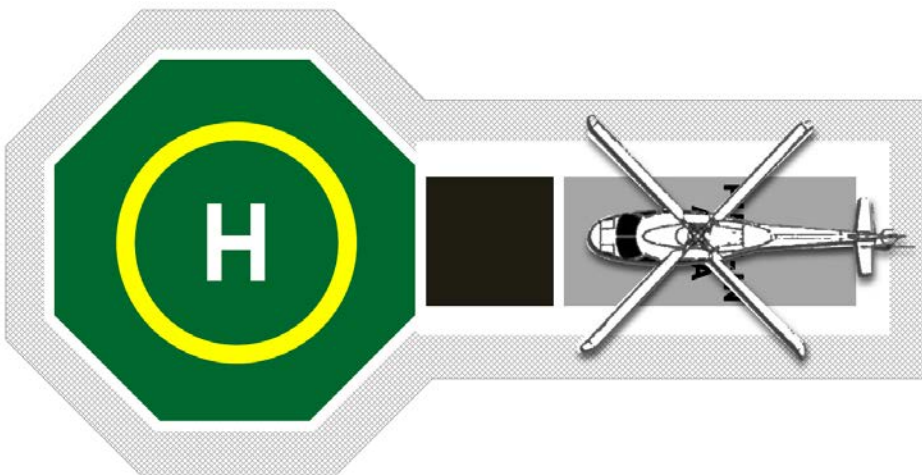

Figure 50: Push-In Parking Area (PIPA) with parked helicopter

12.4.5 Parking Transition Area Markings

One of the following directives shall be used to identify the allowed method of transition into the LPA/PIPA. "Push-in Parking Only", "No Ground Taxi" or "No Hover Taxi", shall be marked on the PTA as shown in Figure 51. The applicable directive shall be marked in text in a white color in the center of the PTA 12" from the TLOF perimeter line with 18 in. (0.45 m) high white letters located on a black background as shown in Figure 51.

Note: If the parking area can accommodate the same size helicopter as allowed on the TLOF without limitations, no markings are necessary

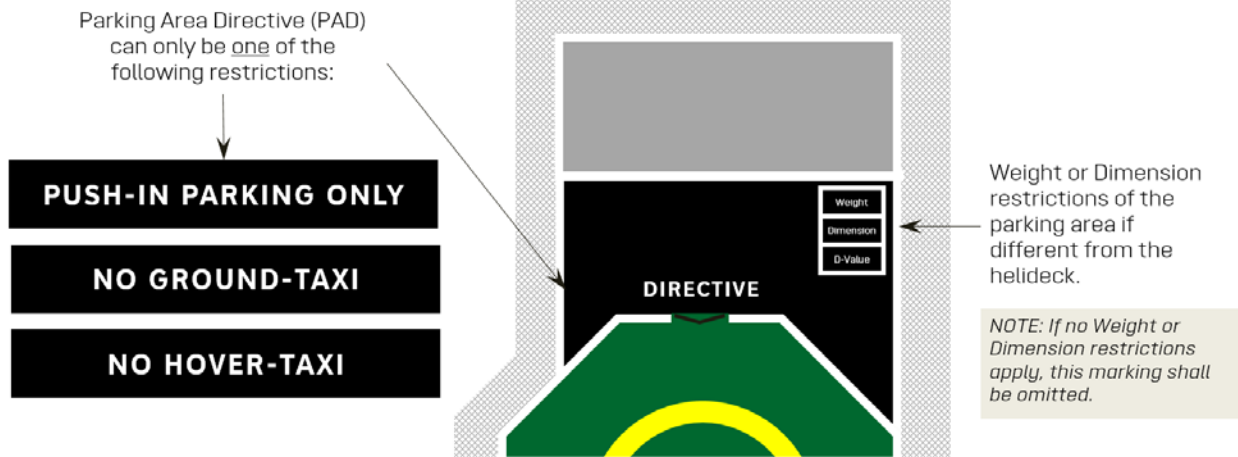

Figure 51: Parking Transition Area (PTA) associated markings

A limited parking area can be downsized to accommodate a helicopter with a lesser D-value than associated with the TLOF (see Annex A paragraph 12.1). In this case, the 'D-value' of the LPA shall be marked on the PTA together with, if applicable, the weight (mass) limit and the LPA dimension(s). All three values shall be marked in a parking area limitations box, as shown in Figure 52 and Figure 53 for imperial units and metric units respectively. The limitations box shall be marked on the right hand side of the PTA at a distance of 12 in. (30 cm) from the TLOF perimeter line as shown in Figure 51 with 18-inch high white letters on a black background with a 4-inch white border located as shown in Figure 52 and Figure 53. This serves as a visual warning to the flight crew that is about to transition a helicopter from the TLOF into the LPA.

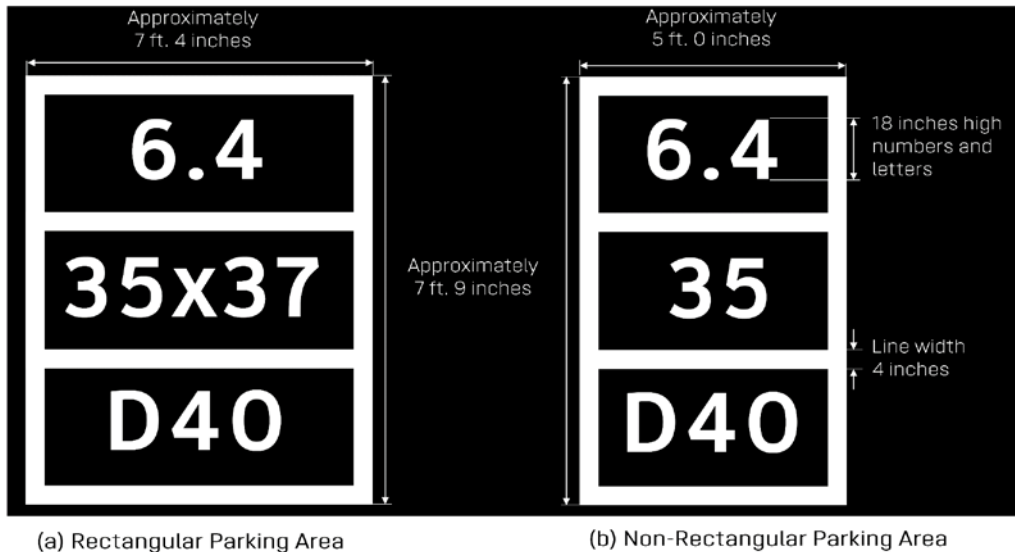

Figure 52: Parking Area size/weight markings (U.S. customary units)

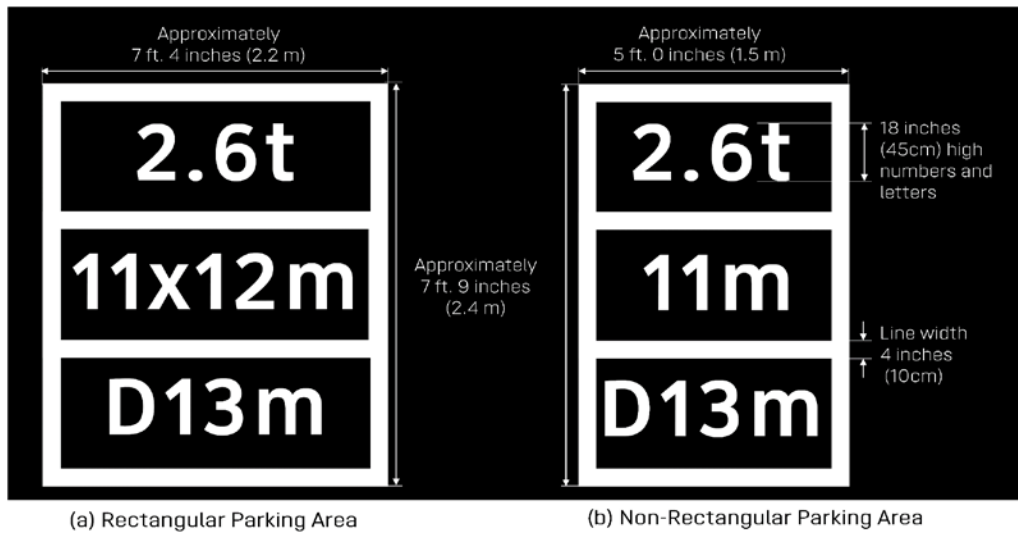

Figure 53: Metric Parking Area size/weight markings

12.5 Lighting of Parking Transition Areas with Limited Parking Areas and Push-in Parking Areas

See 7.4 for lighting of an LPA with hover and/or ground taxi.

For PIPA-only areas, the area shall be lit with floodlighting as shown in Figure 54.

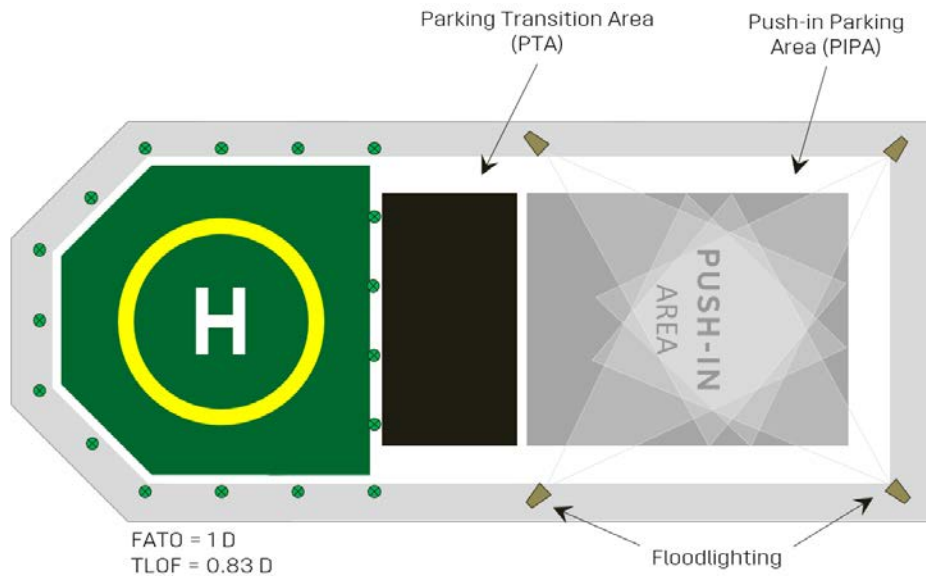

Figure 54: Push-in Parking Area (PIPA) lighting arrangement

ANNEX B: FIREFIGHTING FOAM SYSTEMS

13.1 Siting of Systems

Foam-making equipment shall be of adequate performance and be suitably located to ensure an effective application of foam to any part of the landing area irrespective of the wind strength/direction or accident location when all components of the system are operating in accordance with the manufacturer's technical specifications for the equipment.

For a fixed monitor system (FMS), consideration should also be given to the loss of a downwind foam monitor either due to limiting weather conditions or a crash situation occurring. The design specification for an FMS shall ensure remaining monitors (minimum of 2) are capable of delivering finished foam to the landing area at or above the minimum application rate (see 13.3). For areas of the helideck or its appendages, which, for any reason, may be otherwise, inaccessible to an FMS, it is necessary to provide additional hand-controlled foam branches.

Consideration should be given to the effects of the weather on static equipment. All equipment forming part of the facility shall be designed either to withstand protracted exposure to the elements or to be protected from them. Where protection is the chosen option, it shall not prevent the equipment being brought into use quickly and effectively. The effects of condensation on stored equipment should be considered.

It is essential that all equipment shall be ready for immediate use on, or in the immediate vicinity of, the helideck whenever helicopter operations are being conducted. All equipment shall be located at points having immediate access to the landing area and the location of the storage facilities shall be clearly indicated. The design placement/layout of all such equipment should take into consideration the additional space needed to maintain and service equipment.

13.2 General Information on Foam Quantities and Application Rates

The minimum capacity of the foam production system will depend on the D-value of the helideck, the foam application rate, discharge rates of installed equipment, and the expected duration of application. It is important to ensure that the capacity of the main helideck fire pump is sufficient to guarantee that finished foam can be applied at the appropriate induction ratio and application rate and for the minimum duration to the whole of the landing area when all helideck monitors are being discharged simultaneously. The foam storage containers and tanks must be correctly labeled.

The application rate is dependent on the types of foam concentrate in use and the types of foam application equipment selected. For fires involving aviation kerosene (jet fuel), ICAO has produced a performance test which assesses and categorizes the foam concentrate performance level B or level C foam solution to bring under control a fire associated with a crashed helicopter within the required time constraints achieving an average (theoretical) application rate over the entire landing area (based on the D-circle) of 1.33 gallons per square yard (6.0 ℓ/m^2) per minute for level B foams or 0.83 gallons per square yard (3.75 ℓ/m^2) per minute for level C foams, for a duration of minimum of five (5) minutes.

Most foam-concentrate manufacturers will be able to provide the performance of their concentrate against this test. The decision regarding selection of the foam concentrate and type shall take into account the design characteristics of the foam system and that mixing of different concentrates in the same tank, i.e. different either in make or strength is not acceptable and there are many different strengths of concentrate available.

13.3 Calculation of Application Rate

Given the remote location of helidecks, the overall capacity of the foam system shall exceed that necessary for initial extinction of any fire. Foam concentrates compatible with seawater and meeting at least Performance Level B are used. Level B foams shall be applied at a minimum application rate of 1.33 gallons (USG) per square yard ($6.0 \ell/m^2$) per minute.

The formula for calculating the application rate is as follows.

- r (radius) = $0.5 \times d$ (diameter = D -Value)
- Application rate US customary units = $1.33 \times \pi \times r^2$
- Application rate metric units = $6.0 \times \pi \times r^2$
- An example calculation for a D -value 22.2 m (24.27 yards) helideck is as follows.
- Application rate = $1.33 \times \pi \times (12.13)^2 = 615 \text{ USG/min}$ or $(6.0 \times \pi \times (11.1)^2) = 2,322 \ell / \text{min}$

13.4 Calculation of Minimum Operational Stocks

Using the 22.2 meter example as shown in 13.3, a 1% foam solution discharged over five minutes at the minimum application rate will require $615 \text{ USG} \times 1\% \times 5 = 30.75 \text{ USG}$ of foam concentrate ($2,322 \times 1\% \times 5 = 116 \ell$ of foam concentrate). A 3% foam solution discharged over five minutes at the minimum application rate will require $615 \text{ USG} \times 3\% \times 5 = 92 \text{ USG}$ of foam concentrate ($2,322 \times 3\% \times 5 = 348 \ell$ of foam concentrate).

13.5 Foam Aspiration

Low expansion foam concentrates can generally be applied in either aspirated or unaspirated form. It should be recognized that while unaspirated foam may provide a quick knockdown of any fuel fire, aspiration, i.e. induction of air into the foam solution by monitor or by hand-controlled foam branch (see below), gives enhanced protection after extinguishment.

Note: Wherever non-aspirated foam equipment is selected during design, additional equipment capable of producing aspirated foam for post-fire security/control shall be provided.

13.6 Hose Lines and Hand Controlled Monitors:

Not all fires are capable of being accessed by FMS and on some occasions, the use of monitors may endanger passengers. Therefore, in addition to FMS, there shall be the ability to deploy at least two deliveries with hand-controlled foam branch pipes for the application of aspirated foam at a minimum rate of 60 USG/min ($225 \ell / \text{min}$) through each hose line.

A single hose line, capable of delivering aspirated foam at a minimum application rate of 60 USG/min (225 ℓ/min), may be acceptable where it is demonstrated that the hose line is of sufficient length, and the hydrant system of sufficient operating pressure, to ensure the effective application of foam to any part of the landing area irrespective of wind strength or direction.

The hose line(s) provided should be capable of being fitted with a branch pipe capable of applying water in the form of a jet or spray pattern for cooling, or for specific firefighting tactics.

13.7 Deck Integrated Firefighting System

13.7.1 General

As an effective alternative to an FMS, facility owners are strongly encouraged to consider the provision of a deck integrated firefighting system (DIFFS). These systems typically consist of a series of deck integrated flush fitted nozzles (some designs offer a pop-up variant, where others provide the same dispersion through fixed integrated nozzles known as non-pop-up), with both a horizontal and vertical component, designed to provide an effective spray distribution of foam to the whole of the landing area and protection for the helicopter for a range of weather conditions

Note 1: DIFFS may pose a rollover or skid damage hazard to skid equipped helicopters, and the skids may also damage the DIFFS nozzles and this should be considered in the fire protection design risk assessment. Unless the DIFFS manufacturer is able to provide test evidence by relevant certifying authorities for use with skid fitted helicopters.

Note 2: DIFF Nozzle is recommended to have certification and listing to UL-162 standard. The listing of selected nozzle type shall be with a UL listed, ICAO Level B or ICAO Level C type Foam concentrate.

Although a DIFFS is capable of delivering foam and/or seawater in a spray pattern to the whole of the landing area, the provision of at least one additional hand-controlled foam branch pipe/hose reel is required to address any residual fire(s).

A DIFFS shall be capable of supplying performance level B or level C foam solution to bring under control a fire associated with a crashed helicopter within certain time constraints. Five (5) minutes' foam application capability for a solid plate helideck is generally considered reasonable. In the case of a passive fire-retarding surface with a water-only DIFFS, the discharge duration may be reduced to no less than three (3) minutes. The DIFFS shall achieve an average (theoretical) application rate over the entire landing area (based on the D-value) of 1.33 gallons per square yard (6.0 ℓ/m²) per minute for level B foams, or 0.83 gallons per square yard (3.75 ℓ/m²) per minute for level C foams, for a duration stated before.

The overall design of a DIFFS shall incorporate a method of fire detection and be configured to avoid spurious activation. It shall be capable of manual over-ride by the personnel transported to the facility and from the "mother" installation or from an onshore control room.

Similar to a DIFFS provided for manned installation, a DIFFS provided on an NUI needs to consider the eventuality that one or more nozzles may be rendered ineffective by a helicopter crash. The basic performance assumptions stated in this document shall also apply for a DIFFS located on an NUI.

13.7.2 Deck Integrated Firefighting System Nozzles

The precise number and layout of DIFFS nozzles will be dependent on the specific helideck design, particularly the dimensions of the critical area.

Nozzles shall not be located adjacent to helideck egress points as this may hamper quick access to the helideck by trained rescue crews and/or impede occupants of the helicopter escaping to a safe place beyond the helideck. The number and layout of nozzles shall be sufficient to provide an effective spray distribution of foam over the entire landing area with a suitable overlap of the horizontal element of the spray pattern from each nozzle assuming calm wind conditions.

In meeting the objective for the average (theoretical) application rate specified in 13.2 for Performance Level B or C foams that there may be some areas of the helideck, particularly where the spray patterns of nozzles significantly overlap, where the average (theoretical) application rate is exceeded in practice. Conversely, for other areas of the helideck the application rate in practice may fall below the average (theoretical) application rate specified in 13.2. This is acceptable if the actual application rate achieved for any portion of the landing area does not fall below two-thirds of the rates specified in 13.2 for the critical area calculation.

Note: Where a DIFFS is used in tandem with a passive fire-retarding system demonstrated to be capable of removing significant quantities of unburned fuel from the surface of the helideck in the event of a fuel spill from a ruptured aircraft tank, it is permitted to select a seawater-only DIFFS to deal with any residual fuel burn. A seawater-only DIFFS shall meet the same application rate and duration as specified for a Performance Level B foam DIFFS in 13.2

In a similar way to where an FMS is provided (see 13), the performance specification for a DIFFS needs to consider the likelihood that one or more of the nozzles may be rendered ineffective by the impact of a helicopter on the helideck. Any local damage to the helideck, nozzles, and distribution system caused by a helicopter crash shall not unduly hinder the system's ability to deal effectively with a fire situation. The DIFFS supplier shall be able to verify that the system remains fit for purpose, in being able to bring a helideck fire associated with a crashed helicopter under control within 30 seconds measured from the time the system is producing foam at the required application rate for a range of weather conditions (see 4.5.3).

Note: Typically, a 15% increase in the number of nozzles and flow rate (1.52 gallons per square yard (6.9 l/m²) per minute) is acceptable to meet the requirement to ensure that the DIFFS remains effective in the event of an ineffective nozzle(s). This may not be necessary if the DIFFS system is capable of controlling or extinguishing a fire during a full-scale fire test in witness of recognized certification agency with 15% nozzles blocked.

13.8 Foam Equipment Induction Settings and Testing.

Induction equipment ensures that water and foam concentrate are mixed in the correct proportions and the settings of adjustable inductors, if installed, shall correspond with strength of concentrate in use.

Note: Foam Induction equipment shall be UL-162 or FM-5130 approved or marine class type approved. Adjustable inductors are not recommended for fixed systems.

A competent person shall test all parts of the foam production system, including the finished foam from the nozzle, prior to commissioning and these tests shall assess the performance of the system against original design expectations while ensuring compliance with any relevant pollution regulations. The documented results of these tests shall be supplied to the facility owner.

ANNEX C: ADDITIONAL HELIDECK TIE-DOWN ARRANGEMENTS

Figure 55 through Figure 59 depict additional tie-down arrangements.

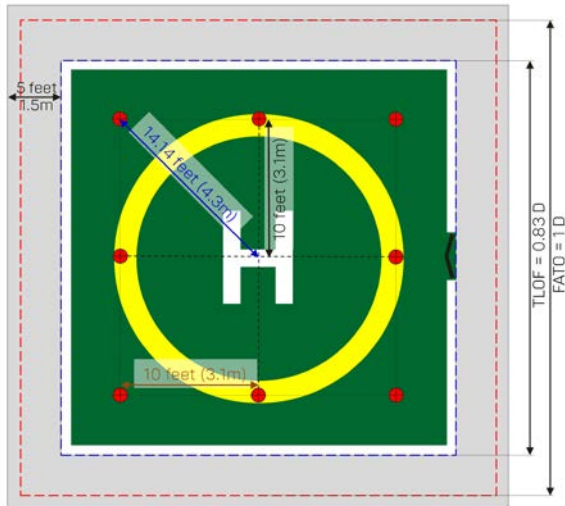

Figure 55: Tie-down point arrangement for an offshore-based helicopter on 0.83D TLOF helideck (a)

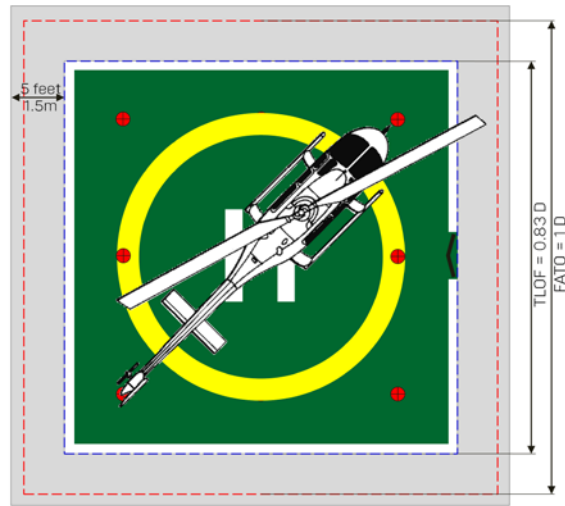
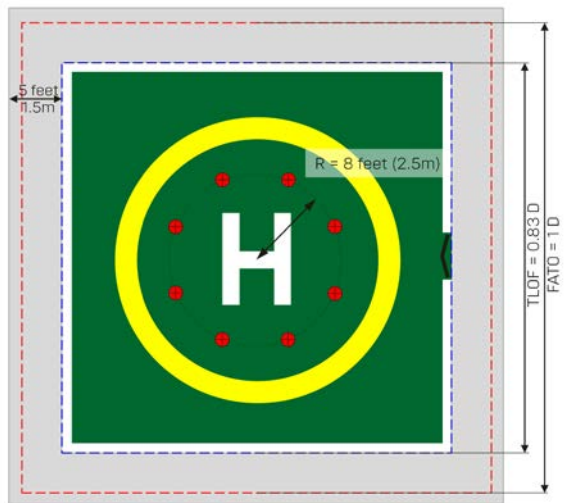

Figure 56: Tie-down point arrangement for an offshore-based helicopter on 0.83D TLOF helideck (b)



Note: A Safety Shelf shall be used when the TLOF is less than 1.0D

Figure 57: Tie-down point arrangement for an offshore-based helicopter on 0.83D TLOF helideck (c)

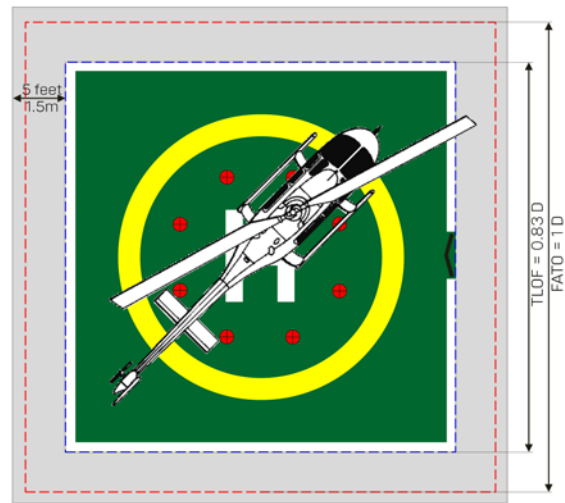
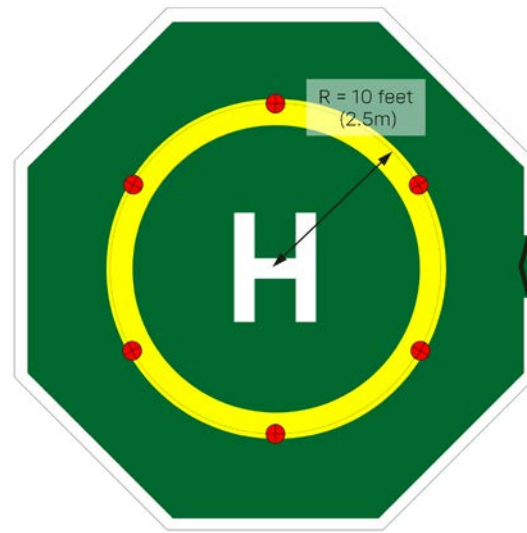

Figure 58: Tie-down point arrangement for an offshore-based helicopter on 0.83D TLOF helideck (d)



1.0 D Helideck < 40 feet (12.3m) Tie-down locations

Figure 59: Tie-down point arrangement for 1.0D TLOF helideck with less than 40 ft. diameter

ANNEX D: HELIDECK TEXT FONTS

All textual markings on helidecks shall use the Clearview Hwy 5-W(R) font type. The Clearview Hwy 5-W variant shall be used as the standard font type; however where horizontal spacing has to be reduced in order to keep helideck markings from overlapping, the horizontal width restricted variant Clearview Hwy 5-W(R) may be used. Details regarding the Clearview Hwy 5-W(R) and Clearview Hwy 5-W font types are shown in the following Tables and Figures.

Dimensions in inches

Table 4: Clearview Hwy 5-W(R) Font Spacing Chart

Character	Left	Width	Right	Character	Left	Width	Right	Character	Left	Width	Right	
A	0.24	3.76	0.24	a	0.40	2.96	0.40	1	0.28	1.80	0.68	
B	0.68	3.04	0.48	b	0.64	2.88	0.48	2	0.36	2.76	0.52	
C	0.52	3.28	0.32	c	0.48	2.72	0.28	3	0.32	2.80	0.52	
D	0.68	3.24	0.52	d	0.48	2.92	0.64	4	0.36	3.16	0.40	
E	0.68	2.56	0.44	e	0.48	2.96	0.48	5	0.48	2.76	0.52	
F	0.68	2.44	0.40	f	0.32	1.92	0.28	6	0.52	2.92	0.48	
G	0.52	3.48	0.52	g	0.48	2.92	0.64	7	0.28	2.84	0.28	
H	0.80	3.08	0.80	h	0.64	2.76	0.64	8	0.52	2.92	0.52	
I	0.68	0.80	0.68	i	0.56	0.92	0.56	9	0.48	2.92	0.52	
J	0.20	2.24	0.68	j	-0.24	1.76	0.56	0	0.56	3.28	0.56	
K	0.68	3.12	0.24	k	0.64	2.84	0.16	&	0.52	3.44	0.28	
L	0.68	2.36	0.36	l	0.64	1.28	0.32	!	0.60	1.0	0.60	
M	0.68	3.68	0.68	m	0.64	4.52	0.64	"	0.44	2.16	0.44	
N	0.68	3.32	0.68	n	0.64	2.76	0.64	#	0.44	3.44	0.44	
O	0.52	3.72	0.52	o	0.48	3.08	0.48	\$	0.36	2.72	0.36	
P	0.68	2.92	0.36	p	0.64	2.92	0.48	¢	0.48	2.60	0.28	
Q	0.52	3.72	0.52	q	0.48	3.20	0.36	/	0.32	2.88	0.32	
R	0.68	3.00	0.48	r	0.64	1.84	0.28	*	0.48	1.92	0.48	
S	0.36	2.88	0.40	s	0.28	2.56	0.40	.	0.44	1.00	0.44	
T	0.28	2.88	0.28	t	0.24	1.96	0.36	,	0.40	1.08	0.40	
U	0.68	3.12	0.68	u	0.64	2.72	0.64	:	0.44	1.00	0.44	
V	0.24	3.40	0.24	v	0.16	3.04	0.16	(0.48	1.08	0.48	
W	0.28	5.32	0.28	w	0.20	4.64	0.20)	0.48	1.08	0.48	
X	0.20	3.44	0.20	x	0.12	3.08	0.12	-	0.60	1.56	0.60	
Y	0.16	3.52	0.16	y	0.16	3.12	0.16	@	0.52	4.04	0.52	
Z	0.40	2.88	0.40	z	0.36	2.44	0.36	=	0.60	2.40	0.60	
									+	0.48	2.68	0.48
									?	0.44	2.56	0.44

Dimensions in inches

Table 5: Clearview Hwy 5-W Font Spacing Chart

Character	Left	Width	Right	Character	Left	Width	Right	Character	Left	Width	Right	
A	0.36	3.76	0.36	a	0.52	2.96	0.52	1	0.40	1.80	0.80	
B	0.80	3.04	0.60	b	0.76	2.88	0.60	2	0.48	2.76	0.64	
C	0.64	3.28	0.44	c	0.60	2.72	0.40	3	0.44	2.80	0.64	
D	0.80	3.24	0.64	d	0.60	2.92	0.76	4	0.48	3.16	0.52	
E	0.80	2.56	0.56	e	0.60	2.96	0.60	5	0.60	2.76	0.64	
F	0.80	2.44	0.52	f	0.44	1.92	0.40	6	0.64	2.92	0.60	
G	0.64	3.48	0.64	g	0.60	2.92	0.76	7	0.40	2.84	0.40	
H	0.80	3.08	0.80	h	0.76	2.76	0.76	8	0.64	2.92	0.64	
I	0.80	0.80	0.80	i	0.68	0.92	0.68	9	0.60	2.92	0.64	
J	0.32	2.24	0.80	j	-0.12	1.76	0.68	0	0.68	3.28	0.68	
K	0.80	3.12	0.36	k	0.76	2.84	0.28	&	0.64	3.44	0.40	
L	0.80	2.36	0.48	l	0.76	1.28	0.44	!	0.72	1.00	0.72	
M	0.80	3.68	0.80	m	0.76	4.52	0.76	"	0.56	2.16	0.56	
N	0.80	3.32	0.80	n	0.76	2.76	0.76	#	0.56	3.44	0.56	
O	0.64	3.72	0.64	o	0.60	3.08	0.60	\$	0.48	2.72	0.48	
P	0.80	2.92	0.48	p	0.76	2.92	0.60	¢	0.60	2.60	0.40	
Q	0.64	3.72	0.64	q	0.60	3.20	0.48	/	0.44	2.88	0.44	
R	0.80	3.00	0.60	r	0.76	1.84	0.40	*	0.60	1.92	0.60	
S	0.48	2.88	0.52	s	0.44	2.56	0.52	.	0.56	1.00	0.56	
T	0.40	2.88	0.40	t	0.36	1.96	0.44	,	0.52	1.08	0.52	
U	0.80	3.12	0.80	u	0.76	2.72	0.76	:	0.56	1.00	0.56	
V	0.36	3.40	0.36	v	0.28	3.04	0.28	(0.60	1.08	0.60	
W	0.40	5.32	0.40	w	0.32	4.64	0.32)	0.60	1.08	0.60	
X	0.32	3.44	0.32	x	0.24	3.08	0.24	-	0.80	1.56	0.80	
Y	0.28	3.52	0.28	y	0.28	3.12	0.28	@	0.64	4.04	0.64	
Z	0.52	2.88	0.52	z	0.48	2.44	0.48	=	0.72	2.40	0.72	
									+	0.60	2.68	0.60
									?	0.56	2.56	0.56

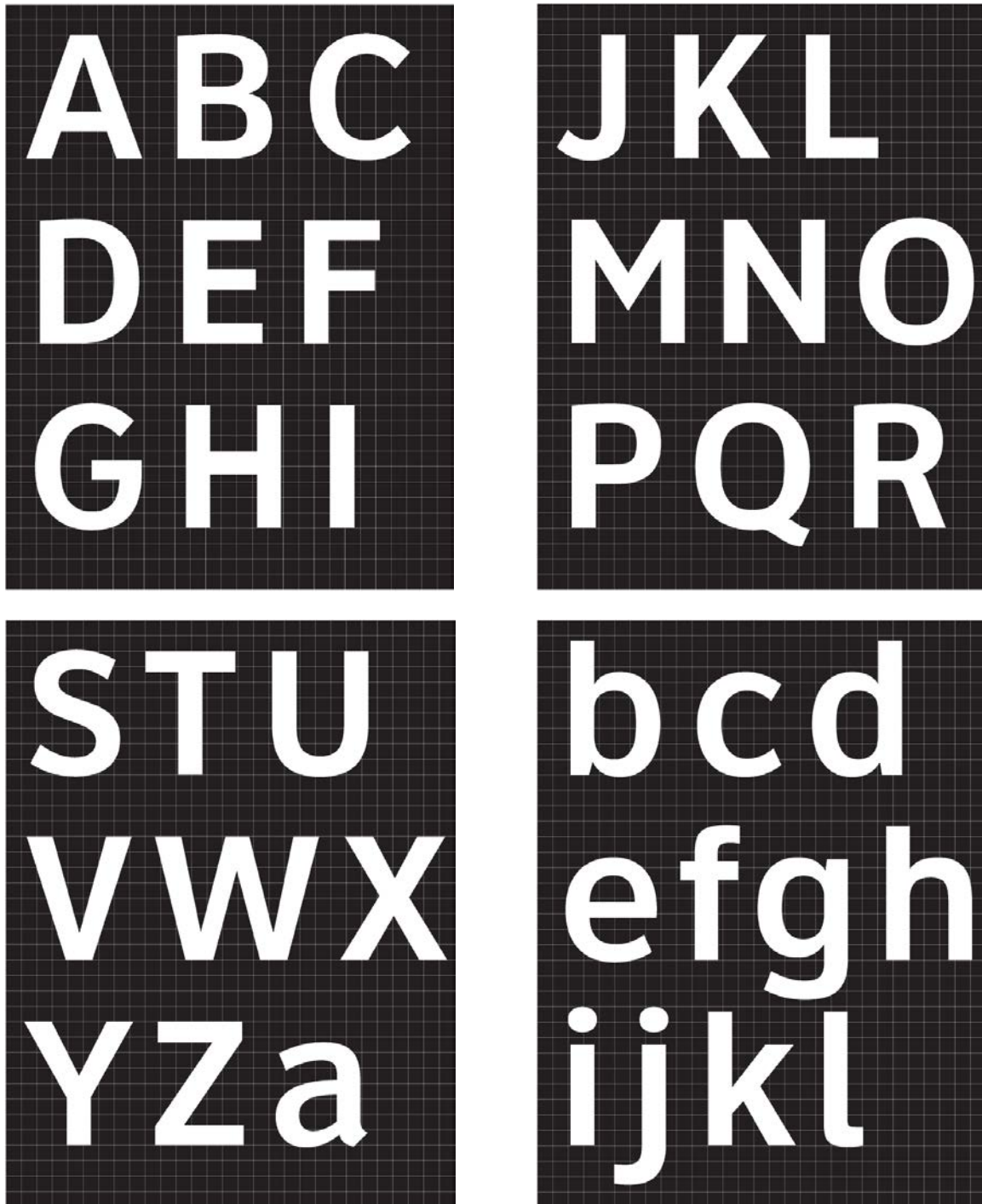

Figure 60: Clearview 5-W and 5-W(R) font character chart

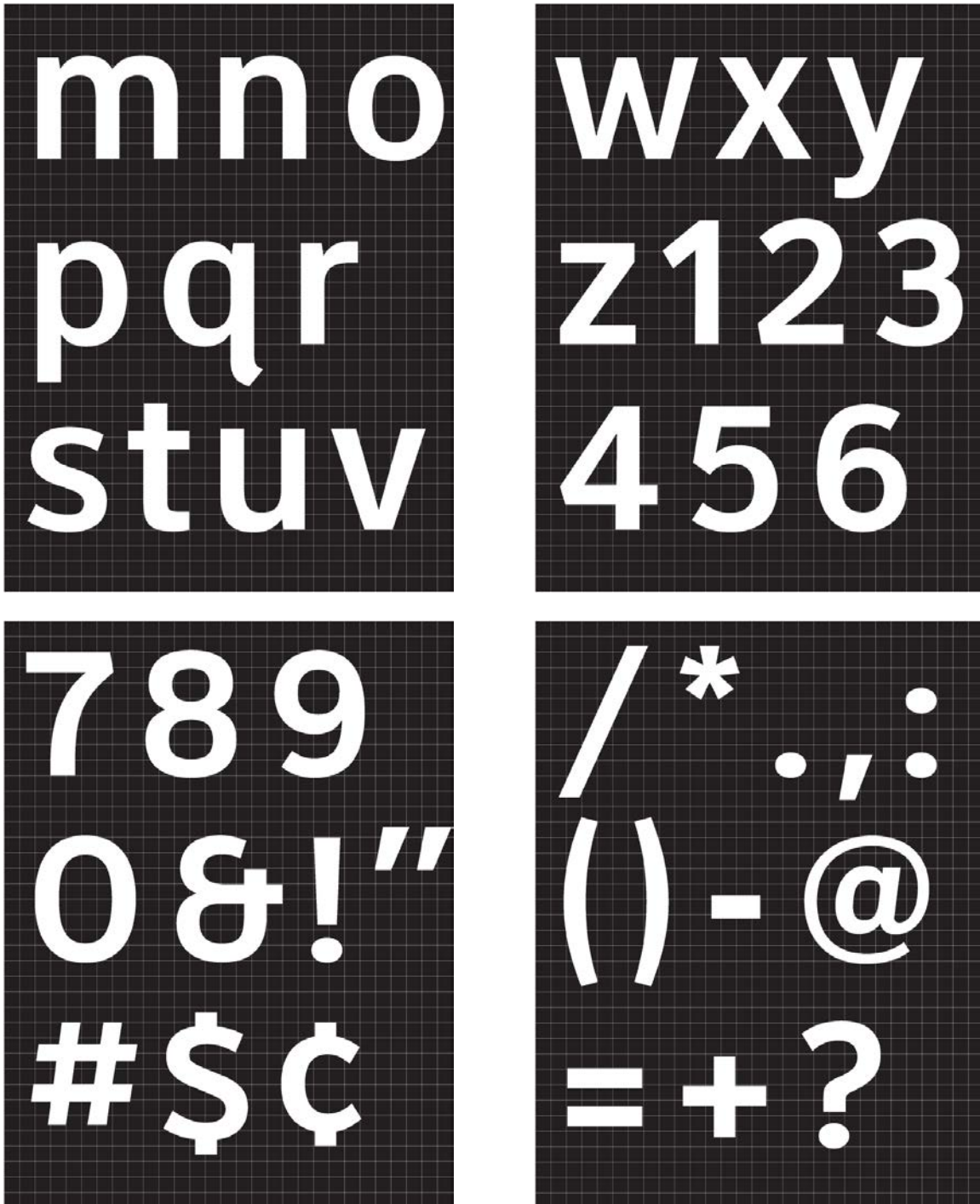

Figure 61: Clearview 5-W and 5-W(R) font character chart (continued).

ANNEX E: PERIMETER LIGHT REQUIREMENTS

16.1 General

The intensity and intensity distribution (beam spread) requirements in this document are based on FAA Engineering Brief No. 87 that gives recommendation for onshore heliports. The intensity and intensity distribution (beam spread) requirements are considered equally applicable to offshore helidecks.

16.2 Light Intensity

The minimum light intensity, as a function of the elevation, with the TLOF elevation as base level, is given in Table 6: Light Intensity and Figure 62: Vertical light intensity distribution. These values shall apply for a full 360° azimuth.

Table 6: Light Intensity

Elevation	Minimum Intensity (cd)	Minimum Average Intensity (cd)
0° to 15°	10	15
16° to 90°	5	—

Vertical Light Intensity Distribution

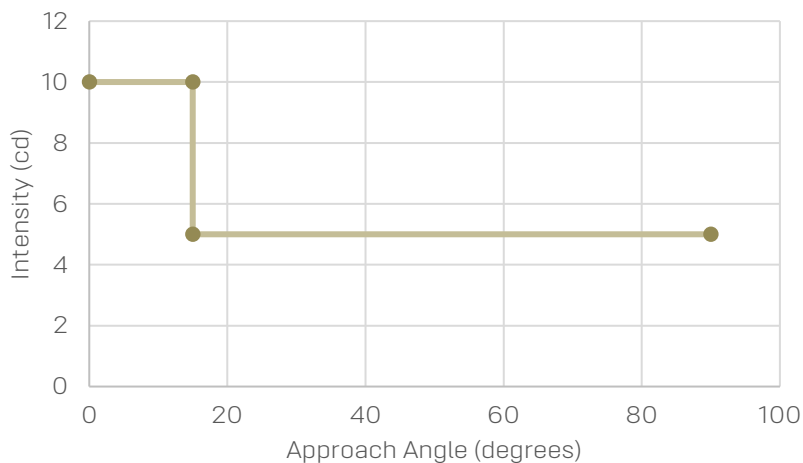

Figure 62: Vertical light intensity distribution

16.3 Color

Perimeter light fixtures that use light emitting diodes (LEDs) must meet the chromaticity requirements for aviation green (TLOF perimeter) and aviation blue (parking area and PTA) requirements in accordance with FAA Engineering Brief No.67. When using incandescent lights the color requirements are defined in SAE AS 25050.

All lighting components and fitments shall meet safety regulations relevant to a helideck environment such as explosion proofing and flammability and, as a minimum, be rated Class 1, Division 2 electrical (see 7.2, Note 1).

TABLE OF FIGURES

Figure 1: Helideck orientation based on wind direction, turbulence, and significant discharge sources 18

Figure 2: Square helideck with 1.0D FATO and 1.0D TLOF 20

Figure 3: Square helideck with 1.0D FATO and 0.83D TLOF 20

Figure 4: 1.0D FATO and 1.0D TLOF with a 1.0D Parking Area..... 22

Figure 5: 1.0D FATO and 0.83D TLOF with a 1.0D Parking Area 22

Figure 6: Obstacle Limitation Sector and OFS for helideck with a circular 1.0D FATO and 1.0D circular TLOF..... 24

Figure 7: Obstacle Limitation Sector and OFS for helideck with a circular 1.0D FATO and 0.83D circular TLOF 25

Figure 8: LOS and OFS for octagonal helideck with a 1.0D FATO and 1.0D TLOF 26

Figure 9: LOS and OFS for helideck with a 1.0D FATO and 0.83D octagonal TLOF..... 27

Figure 10: OFS, LOS, and OFDS below a helideck with 1.0D circular TLOF 28

Figure 11: OFS, LOS, and OFDS below a helideck with 0.83D square TLOF..... 28

Figure 12: Obstacle Free Sector (OFS) and Obstacle Free Dropdown Sector (OFDS)..... 29

Figure 13: Obstacle Free Sector swung by 15 degrees..... 30

Figure 14: Turbulence with and without a helideck air gap..... 39

Figure 15: Tie down point arrangement 46

Figure 16: Relationship of the TDPM to LOS for a 1.0D TLOF 47

Figure 17: Relationship of the TDPM to LOS for a 0.83D TLOF..... 48

Figure 18: TDPM and “H” marking 48

Figure 19: Helideck ‘H’ Marking..... 49

Figure 21: Size and weight markings for 1.0D 52.5 ft. medium helicopter rectangular helideck 50

Figure 22: Helideck size and weight markings in U.S. customary units 51

Figure 23: Size and weight markings for a 0.83D square helideck 52

Figure 24: Size and weight markings for medium helicopter 0.83D octagonal helideck..... 53

Figure 25: Size and weight markings for SI units 54

Figure 26: Example of a 0.1D displaced TDPM and ‘H’ for a helideck with 0.83D TLOF and 1.0D FATO 56

Figure 27: Example of a 0.1D displaced TDPM and ‘H’ for a helideck with 1.0D TLOF and 1.0D FATO 57

Figure 28: Example of a 0.1D displaced TDPM and ‘H’ for a helideck with 0.83D TLOF and 1.0D FATO 58

Figure 29: Chevron marking 59

Figure 30: Displaced chevron marking 59

Figure 31: Parking Area and Parking Transition Area markings for 1.0D FATO, 1.0 D TLOF, and 1.0D PA..... 60

Figure 32: Obstacle Warning Marking for OFDS 62

Figure 33: “No Nose” marking 63

Figure 34: Manned facility Exit marking..... 64

Figure 35: Unmanned facility Exit marking with Walkway marking..... 65

Figure 36: Square shaped TLOF helideck Perimeter Lighting arrangement 67

Figure 37: Octagon shaped TLOF helideck Perimeter Lighting arrangement..... 68

Figure 38: Typical Floodlighting arrangement 69

Figure 39: Parking Area lighting arrangement 70

Figure 40: 1.0D FATO, 1.0D TLOF, and Limited Parking Area of 0.83D (RD)..... 80

Figure 41: Touchdown Parking Circle (TDPC) marking and Parking Circle Orientation Marking (PCOM)..... 81

Figure 42: Limited Parking Area (LPA) of 0.83D with Parking Circle Orientation Marking (PCOM)..... 82

Figure 43: Helicopter parked using Parking Circle Orientation Marking (PCOM)..... 82

Figure 44: ‘No Nose’ marking and Parking Circle Orientation Marking (PCOM) on TDPC 83

Figure 45: ‘No Nose’ marking and PCOM on TDPC..... 84

Figure 46: ‘No Nose’ marking and PCOM on TDPC with parked helicopter 84

Figure 47: ‘No Nose’ marking and PCOM on TDPC..... 85

Figure 48: ‘No Nose’ marking and PCOM on TDPC with parked helicopter 85

Figure 49: Push-In Parking Area (PIPA).....	86
Figure 50: Push-In Parking Area (PIPA) with parked helicopter.....	87
Figure 51: Push-In Parking Area (PIPA) with parked helicopter.....	87
Figure 52: Parking Transition Area (PTA) associated markings.....	88
Figure 53: Parking Area size/weight markings (U.S. customary units).....	88
Figure 54: Metric Parking Area size/weight markings.....	89
Figure 55: Push-in Parking Area (PIPA) lighting arrangement.....	89
Figure 56: Tie-down point arrangement for an offshore-based helicopter on 0.83D TLOF helideck (a).....	95
Figure 57: Tie-down point arrangement for an offshore-based helicopter on 0.83D TLOF helideck (b).....	95
Figure 58: Tie-down point arrangement for an offshore-based helicopter on 0.83D TLOF helideck (c).....	95
Figure 59: Tie-down point arrangement for an offshore-based helicopter on 0.83D TLOF helideck (d).....	95
Figure 60: Tie-down point arrangement for 1.0D TLOF helideck with less than 40 ft. diameter.....	96
Figure 61: Clearview 5-W and 5-W(R) font character chart.....	100
Figure 62: Clearview 5-W and 5-W(R) font character chart (continued).....	101
Figure 63: Vertical light intensity distribution.....	102

LIST OF TABLES

Table 1: References.....	10
Table 2: Terms and definitions.....	14
Table 3: Abbreviations.....	16
Table 4: Clearview Hwy 5-W(R) Font Spacing Chart.....	98
Table 5: Clearview Hwy 5-W Font Spacing Chart.....	99
Table 6: Light Intensity.....	102

INDEX

- O**
- 0.83D, 11, 12, 13, 19, 20, 21, 22, 23, 25, 27, 28, 32, 47, 48, 51, 52, 53, 56, 58, 60, 66, 79, 80, 82, 83, 95
- 1**
- 1.0D, 10, 11, 19, 20, 21, 22, 23, 24, 25, 26, 27, 28, 29, 31, 32, 33, 45, 47, 50, 55, 56, 57, 58, 60, 66, 79, 80, 83, 96
- C**
- CAFS, 15, 36, 38
CFD, 15, 33, 40
- D**
- DIFFS, 10, 15, 35, 38, 92, 93
DLB, 15
D-Value, 10, 51, 91
- F**
- FATO, 10, 15, 19, 20, 22, 23, 24, 25, 26, 27, 29, 31, 32, 33, 55, 56, 57, 58, 59, 60, 80
FMS, 15, 90, 91, 92, 93
- H**
- HMS, 15, 76
- I**
- IFR, 15, 75
- L**
- LED, 15, 66, 69
LOS, 11, 13, 15, 19, 21, 23, 26, 27, 28, 29, 30, 32, 37, 41, 47, 48, 57, 59, 61, 62, 68, 70, 79
LPA, 11, 13, 15, 21, 22, 60, 79, 80, 82, 86, 87, 88, 89
- M**
- Minimum Structure, 12
MTOM, 10, 11, 15, 42, 43, 44, 51
MTOW. *See* MTOM
- N**
- NLB, 15
NUI, 15, 17, 37, 92
- O**
- Obstacle, 11, 12, 15, 23, 24, 25, 29, 30, 31, 32, 54, 61, 62
OFDS, 12, 15, 23, 28, 29, 30, 31, 32, 35, 61, 62
OFS, 12, 13, 15, 19, 21, 23, 24, 25, 26, 27, 28, 29, 30, 31, 32, 33, 49, 54, 56, 57, 59, 70, 79
- P**
- PA, 12, 13, 16, 21, 23, 32, 35, 36, 37, 38, 44, 59, 60, 63, 79, 80
PCF, 16, 34
PCOM, 16, 81, 82, 83, 84, 85
PIPA, 13, 16, 21, 22, 37, 60, 79, 80, 86, 87, 89
PPA, 12, 13, 16, 21, 79, 81, 83
PTA, 11, 12, 13, 16, 21, 23, 36, 38, 44, 60, 63, 69, 79, 80, 86, 87, 88, 103
- R**
- RD, 13, 16, 79, 80
Reference Point, 13, 55
Return Period, 13
RFF, 16, 37
- S**
- Safety Net, 13, 24, 26, 44, *See* Perimeter Safety Net
Safety Shelf, 13, 25, 27, 44
SHR, 16, 76
- T**
- TDPC, 13, 16, 60, 79, 80, 81, 82, 83, 84, 85, 86
TDPM, 14, 16, 19, 29, 31, 46, 47, 48, 49, 51, 56, 57, 58, 61, 63, 64, 66, 68
TLOF, 10, 11, 12, 13, 14, 16, 18, 19, 20, 21, 22, 23, 24, 25, 26, 27, 28, 29, 30, 31, 32, 33, 35, 36, 37, 38, 39, 41, 42, 43, 44, 45, 47, 48, 49, 50, 51, 53, 54, 55, 56, 57, 58, 59, 60, 63, 64, 66, 67, 68, 69, 71, 73, 75, 79, 80, 81, 83, 86, 87, 88, 95, 96, 102, 103
- U**
- UPS, 16, 72

